

Joint Design Guide

Supplementary Planning Document
Adopted in June 2022

Joint Design Guide

The Joint design guide is intended to help you to develop the design of any proposal and it has been prepared to guide you through all steps and stages of the design process.

The design guide is intended to assist landowners, developers, applicants, agents, designers and planners through all stages of the design and planning process to achieve high quality and sustainable development.

The design guide is a Supplementary Planning Document adopted in June 2022 and is a material consideration when determining planning applications.

The guide consists of sections covering specific subjects these are; place and setting, natural environment, movement and connectivity, space and layout, built form, and climate and sustainability. You need to consider all of these from the outset.

All applicants are required to examine their proposals against the lists of principles which we will use to assess the scheme. It is unlikely that planning permission will be granted for development proposals that do not demonstrate consistency with the principles set out in the design guide.

Both councils ran a consultation to get feedback from stakeholders and the public on the draft Joint Design Guide at the beginning of 2022. A summary of the responses can be found within the consultation report here. The comments were used to draft the final Joint Design Guide, which was adopted by South Oxfordshire District Council by its cabinet on 23rd June 2022 and Vale of White Horse District Council by its cabinet on 24th June 2022.

Supporting Documents:

[Adoption statement \(2022\)](#)

[Consultation report \(2022\)](#)

[Consultation report appendix A – Survey and full results \(2022\)](#)

[Consultation report appendix A2 – List of comments \(2022\)](#)

[Consultation report appendix B – Consultation documents](#)

[\(2022\) Equalities Impact Assessment \(2021\)](#)

Contents

About the Design Guide

Purpose of the guide	1
Design and Planning	2
How to use the guide	5
Design objectives	7

About South and Vale

An introduction	11
Settlements and designations	13
Landscape character areas	15
Neighbourhood plan areas	17

Place and setting

Analysis	19
Concept	21

Natural environment

Natural features and resources	27
The value of trees	33
The value of biodiversity	41

Movement and connectivity

Creating a network	47
The design of streets	55
Streets as spaces	61

Space and layout

Framework and structure	67
Plots and amenity	77
Storage, services and utilities	85
Parking strategy and solutions	91
Open space design	99
Play space design	105
Public art	113

Built form

General principles	117
Apartments	127
Householder extensions and outbuildings	132
Rural and low density dwellings	159
Heritage and conservation	165
Traditional shopfront design	171
Non-domestic buildings	176
Mixed use development	181
Materials, maintenance and management	186

Climate and sustainability

Overview	191
Sustainable development	193
Reducing carbon emissions	203
Standards and certifications	207
Reducing embodied carbon	213
	213

Glossary	217
----------	-----

Purpose of the guide

About the guide

This Design Guide has been prepared as part of South Oxfordshire and Vale of White Horse District Councils' commitment to securing the highest quality development within the districts.

The guide builds upon and replaces previous local design guides and aligns with the National Design Guide (2019). It is intended to assist landowners, developers, applicants, agents, designers, and planners in the process of developing high quality development and in assessing its design quality.

The guide is a Supplementary Planning Document (SPD), and as such, will be a material consideration in determining planning applications submitted to the Council. It carries considerable weight in decision-making, having been subject to scrutiny and amendment throughout a public consultation process.

Its purpose

To improve the standard of design in all developments in South Oxfordshire and the Vale and ensure that only developments of the highest quality and sustainability are delivered.

The guide:

- is relevant for all scales of development (for example householder extensions, non-domestic buildings or large residential developments);
- defines the meaning of relevant design phrases and terms;
- must be read in conjunction with other statutory plans;
- provides a simple set of design principles that applications should meet and are easy to follow;
- helps applicants gain a better understanding of how to deliver good design by providing guidance on best practice, design principles and the terms and phrases used by design specialists;
- provides an evaluation tool to help assess developments coming forward;
- helps applicants to have the best chance of getting approval when considering design.

Design and Planning

Design and Planning

There is a list of design principles set out in each chapter to be addressed by all applicants. These are used to assess schemes and their design at all planning application stages.

All applicants will be required to test their proposals against the lists of design principles that we will also use to assess the scheme against. By following this process, applicants will be more likely to obtain planning permission.

The delivery of high-quality development is dependent on undertaking a robust design and planning process. **The diagrams below illustrate the process that we would strongly encourage all applicants to follow**, to give yourself the best chance of securing planning permission with high-quality development.

Throughout the guide we will specify which design principles are applicable to which scales of development, major or minor applications. **Unless otherwise specified, all design principles are applicable to all scales of development, a * indicates for minor applications only, ** indicates for major applications only.** Supporting text is numbered throughout each theme for ease of reference.

We offer pre-application advice for new development and can draw on our design team to provide specialist input. We offer advice at all stages of the design process and for all scales of developments.

For more information about these services, please contact us or visit our website here:

[South Oxfordshire District Council](#)

[Vale of White Horse District Council](#)

To check if your proposal falls under permitted development see:

[Planning Portal – Permitted development](#)

Additional guidance and documents beyond our guide

There is design guidance available beyond our guide at a national level, our design guide specifies what is best at a local level, as well as the Councils' own local plans and neighbourhood plans. Neighbourhood Plans are part of the development plan and form an important part of the design process and therefore must be considered.

[The National Planning Policy Framework \(NPPF, 2021\)](#)

[Local Plans for South Oxfordshire](#)

[Local Plans for Vale of White Horse](#)

[National Design Guide \(2019\)](#)

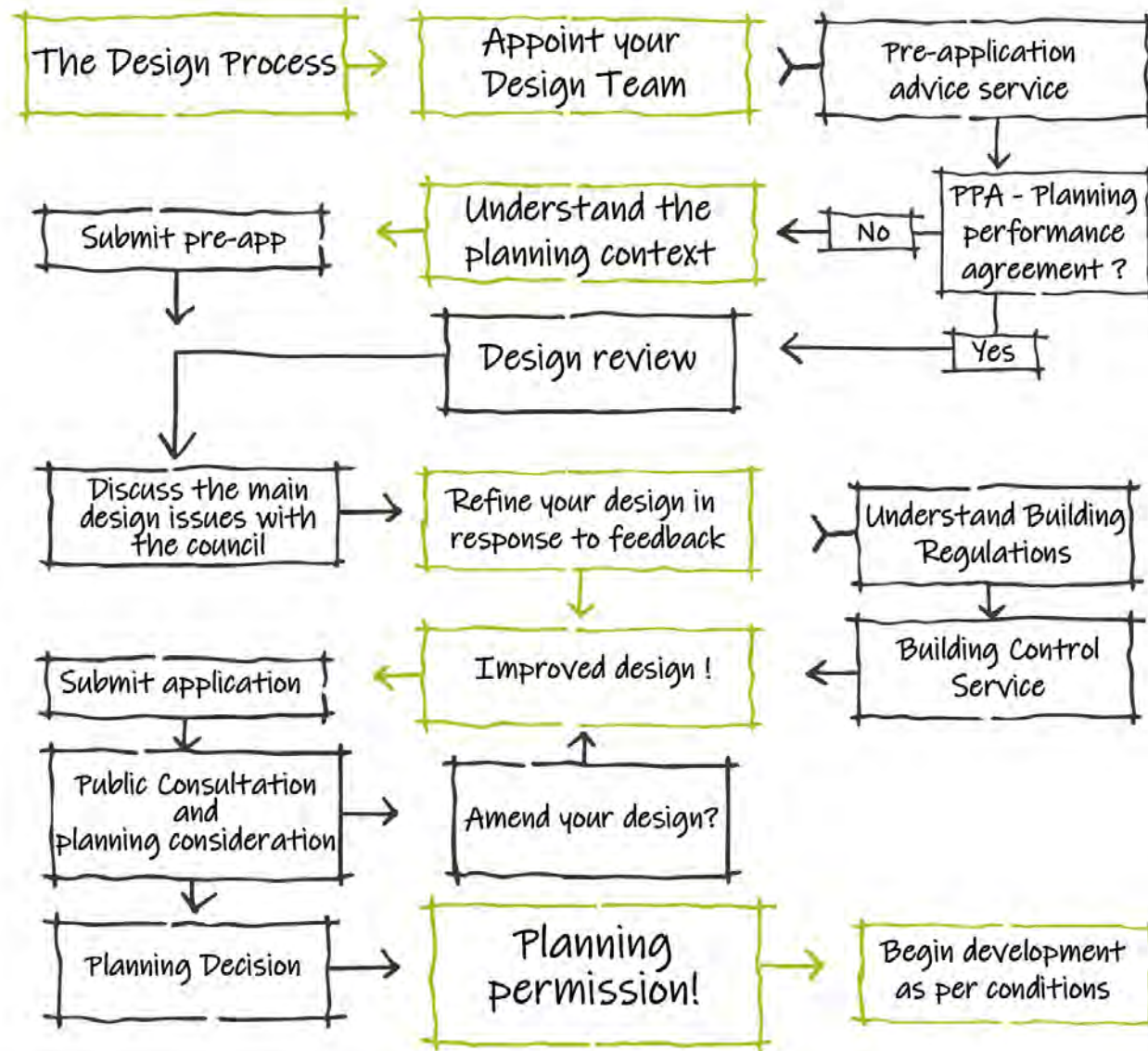
[National Design Code Part 1: The Coding Process \(2021\)](#)

[National Design Code Part 2: Guidance Notes \(2021\)](#)

[Neighbourhood Plans for South Oxfordshire and the Vale](#)

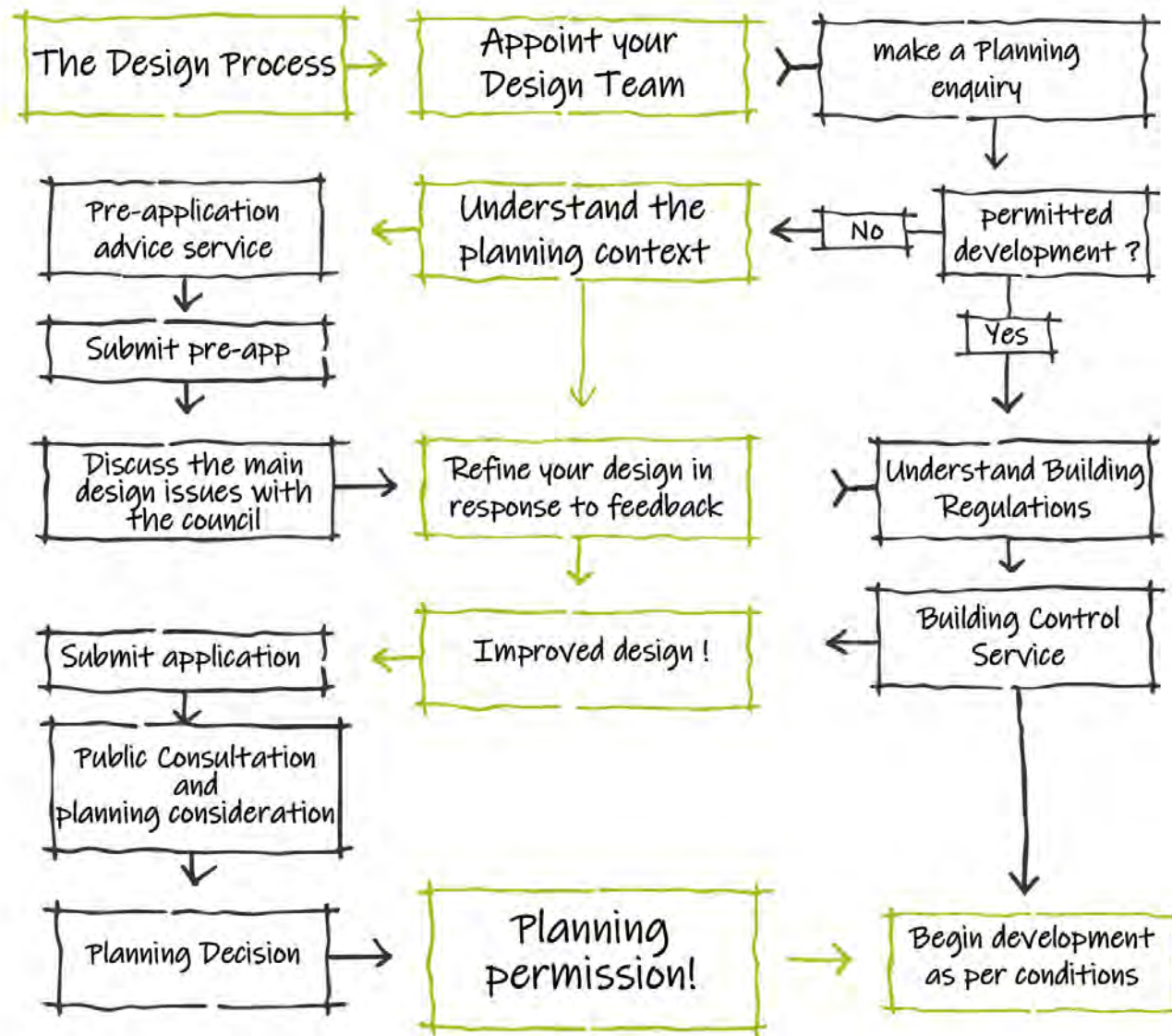
Major development

Major development is defined as; for housing, development where 10 or more homes will be provided, or the site has an area of 0.5 hectares or more. For non-residential development it means additional floorspace of 1,000m² or more, or a site of 1 hectare or more, or as otherwise provided in the Town and Country Planning (Development Management Procedure) (England) Order 2015.



Minor development

Minor development is defined as; anything smaller than the criteria for major developments. That is development where less than 10 homes will be provided, or the site area less than 0.5 hectares. For non-residential development it means floorspace less than 1,000m², or a site less than 1 hectare, or as the definition for major development is otherwise provided in the Town and Country Planning criteria less than stated for (Development Management Procedure) (England) Order 2015.



How to use the guide

Follow the steps

These are aimed at helping you inform, communicate, and support the design decisions you make.

Inform your design:

Development has an instant and lasting impact on a place and on its surroundings. **The impact of all new development needs to be properly understood and addressed.**

Specific technical studies need to be undertaken to understand the features of a site and its surrounding area. For example, surveys that assess the quality of trees, landscape, or geology, identify the presence of a particular habitat or species, or identify transport and movement information. The results of these studies need proper consideration and should inform the design of your development.

Communicate your design:

When a planning application is made, or advice is sought from the councils, it is important that people can understand the design of your proposal. **This guide demonstrates effective ways to communicate your design.** A proposal that is visualised and well explained leads to better results when considering design.

Support your design:

There may be **technical standards** which need considering for different aspects of a proposal.

The most relevant of these are listed in each section of the guide, **along with additional resources.** These can be used to further support your design proposal through evidence-based practice.

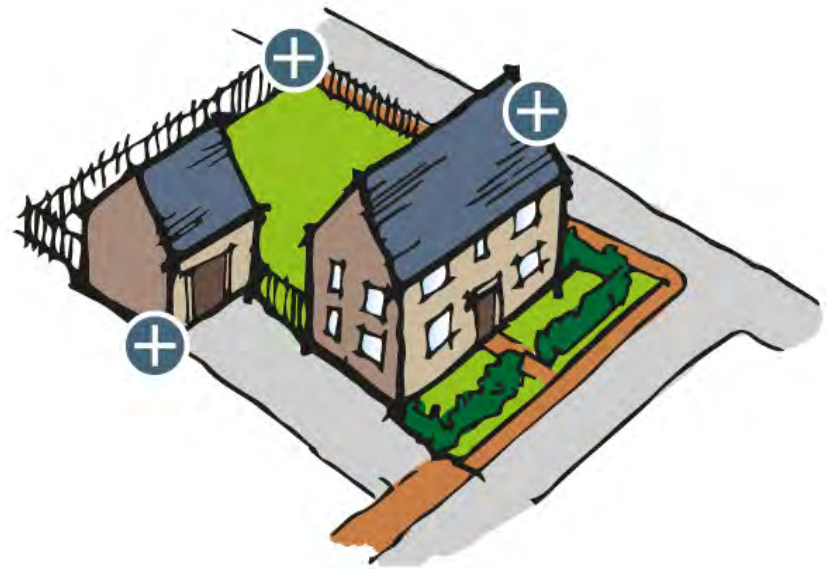
Design principles

The design principles set out in the guide are the criteria by which we assess your design.

After each section:

This guide provides a set of design principles applicable to all scales of development (unless otherwise specified), for you to follow to achieve high-quality development.

You need to ensure your design meets the criteria; the councils will be assessing the scheme against them. Not all criteria are relevant to all design proposals, pre-application discussions will help determine what criteria are relevant to your proposal.



Glossary

Technical terms are defined in the Glossary which can be found in the main Menu.

Drawings

Throughout the [website](#) there are a series of interactive plans. These provide further information and design guidance on certain aspects through illustrated examples.

In this printed document further information is provided in appendix 1.

Design objectives

Delivering high quality, sustainable and beautiful development

The main planning objectives of the UK government is to deliver sustainable, high quality and beautiful development.

What do we mean by sustainable development?

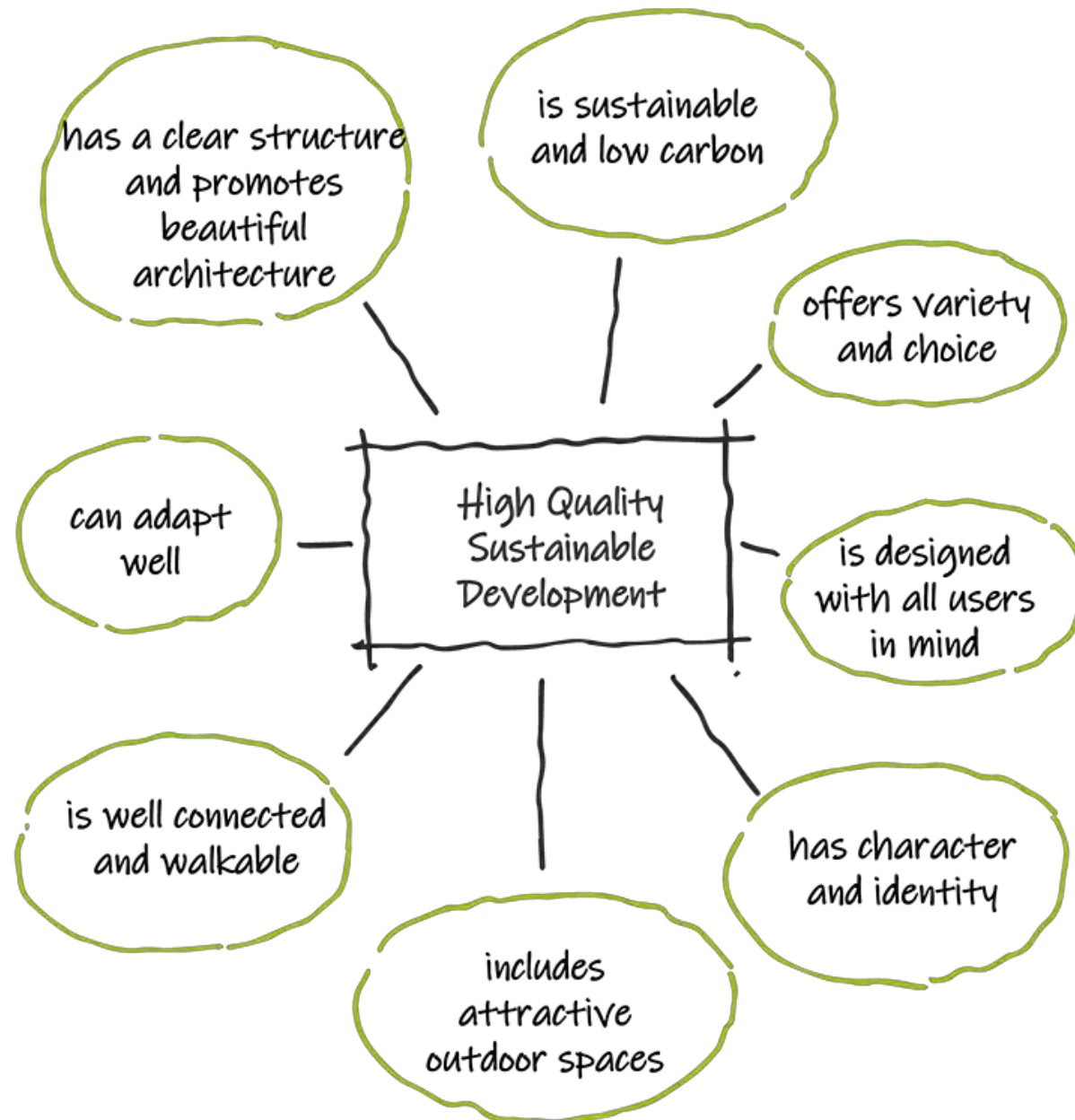
Development that meets the needs of the present without compromising the ability of future generations to meet their own needs. It is central to the economic, environmental and social success of the country and is the core principle underpinning planning. Simply stated, the principle recognises the importance of ensuring that all people should be able to satisfy their basic needs and enjoy a better quality of life, both now and in the future. Sustainable development is development that delivers places of high quality for everyone and will continue to work well into the future.

What do we mean by high quality?

Places that are of high quality are beautiful places and environments in which people want to live, work and visit. They allow us to carry out daily activities with ease and offer us choice in how to do them. In short, high-quality places enhance our lives and wellbeing.

What do we mean by places?

A place is more than just a building and the appearance of that building. It is how the buildings, streets and spaces work together, as well as how we use them and how they make us feel.



Objectives

Meeting the following objectives is critical in delivering high quality sustainable development. These objectives should be considered at the outset and throughout the design process.

Ensure the proposal:

- is informed by a contextual analysis of the area and responds positively to the site and its surroundings;
- uses land efficiently whilst respecting the existing landscape character and delivers a net gain in biodiversity;
- incorporates and/or links to a well-defined network of green and blue infrastructure;
- is sustainable and resilient to climate change, minimises carbon emissions and mitigates water run-off and flood risks;
- takes into account landform, layout, building orientation, massing and landscaping;
- provides a clear and permeable hierarchy of streets, routes and spaces to create safe and convenient ease of movement by all users;
- has streets and spaces that are well overlooked creating a positive relationship between fronts and backs of buildings;
- clearly defines public and private spaces;
- has access to local services and facilities and, where needed, incorporate mixed uses, facilities and co-located services as appropriate. This should include good access to public transport and should provide a wide range of house types and tenures;
- respects the local context working with and complementing the scale, height, density, grain, massing, type, details of the surrounding area;
- conserves and where possible, enhances the significance of heritage assets, for example listed buildings, registered parks and gardens, archaeological remains and historic features, spaces, routes and views;
- secures a high-quality public realm with well managed and maintained public areas;
- is of a high quality with no differentiation between market and affordable housing;
- is designed to take account of possible future development in the local area;

- is built to last, functions well and adapts to changing requirements of occupants;
- understands and addresses the needs of all potential users to ensure inclusive design;
- creates safe communities and reduces the likelihood of crime and antisocial behaviour;
- creates healthier places by providing opportunities to transform lifestyles for the better;
- ensures an appropriate level of well-integrated and imaginative solutions for car and bicycle parking and external storage including bins.

An introduction

Goal: Understanding the districts

South Oxfordshire and the Vale are exceptionally beautiful districts, rich in architecture of different periods, styles and materials and rich in landscape quality, with a large proportion of the districts being designated as an Area of Outstanding Natural Beauty (AONB). As well as respecting and enhancing the existing natural and built environment of South Oxfordshire and the Vale, the councils expect the design of new development to be similarly outstanding for the benefit of local residents, visitors and future generations. In the AONB's any proposed development must demonstrate that it conserves and enhances the special qualities of that AONB.

The district of South Oxfordshire covers nearly 670km² and the Vale covers an area of some 580km². The district boundaries of South Oxfordshire reach from the edge of the city of Oxford to the north-west, along the borders of Buckinghamshire and Berkshire to the outskirts of Reading to the south. The Vale of White Horse district falls between the larger centres of Oxford to the north-east and Swindon to the south-west. South Oxfordshire has four main towns: Didcot, Henley, Thame and Wallingford. Larger villages within South Oxfordshire provide a range of services and facilities. The main settlements within the Vale are the three historic market towns of Abingdon-on-Thames, Faringdon and Wantage, which provide essential services for the surrounding rural areas. There are also two local service centres at Botley and Grove. The districts also have significant employment areas of national note, including Harwell Campus and Milton Science Parks in the Vale and Culham Science Centre in South Oxfordshire.

The districts are predominantly rural in nature, with most of the land being agricultural. For South Oxfordshire, the main exception to this is within the south-east where the wooded Chiltern Hills rise sharply from the Thames Valley. Most of the southern end of the district sits in either the Chilterns or North Wessex Downs Area of Outstanding Natural Beauty (AONB). The north-east of South Oxfordshire district forms part of the Oxford Green Belt. A large proportion of the districts have a Green Belt or AONB designation. For Vale, the southern end of the district is within the North Wessex Downs Area of Outstanding Natural Beauty (AONB) and the north-west of the district forms part of the Oxford Green Belt.



South Oxfordshire and the Vale 1,257 km2



The Chilterns and North Wessex Downs AONB



121 Conservation areas



5482 Listed buildings



156 Towns and villages



20 Registered Parks and Gardens



The River Thames



The Oxford Green Belt



121 Scheduled monuments



1 Registered battlefield

Settlements and designations

Goal: Understanding the districts









The two districts are protected by numerous areas of special designation. These include Areas of Outstanding Natural Beauty (AONB), Green Belt land, listed buildings and conservation areas, which seek to preserve the districts natural and built environment for future generations.

The map below illustrates the locations of these designations across the two districts and provides further information about them. The map should not be viewed as definitive, and applicants should carry out their own analysis or refer to the public Geographics Information System (GIS) database provided by South Oxfordshire and the Vale for further details.

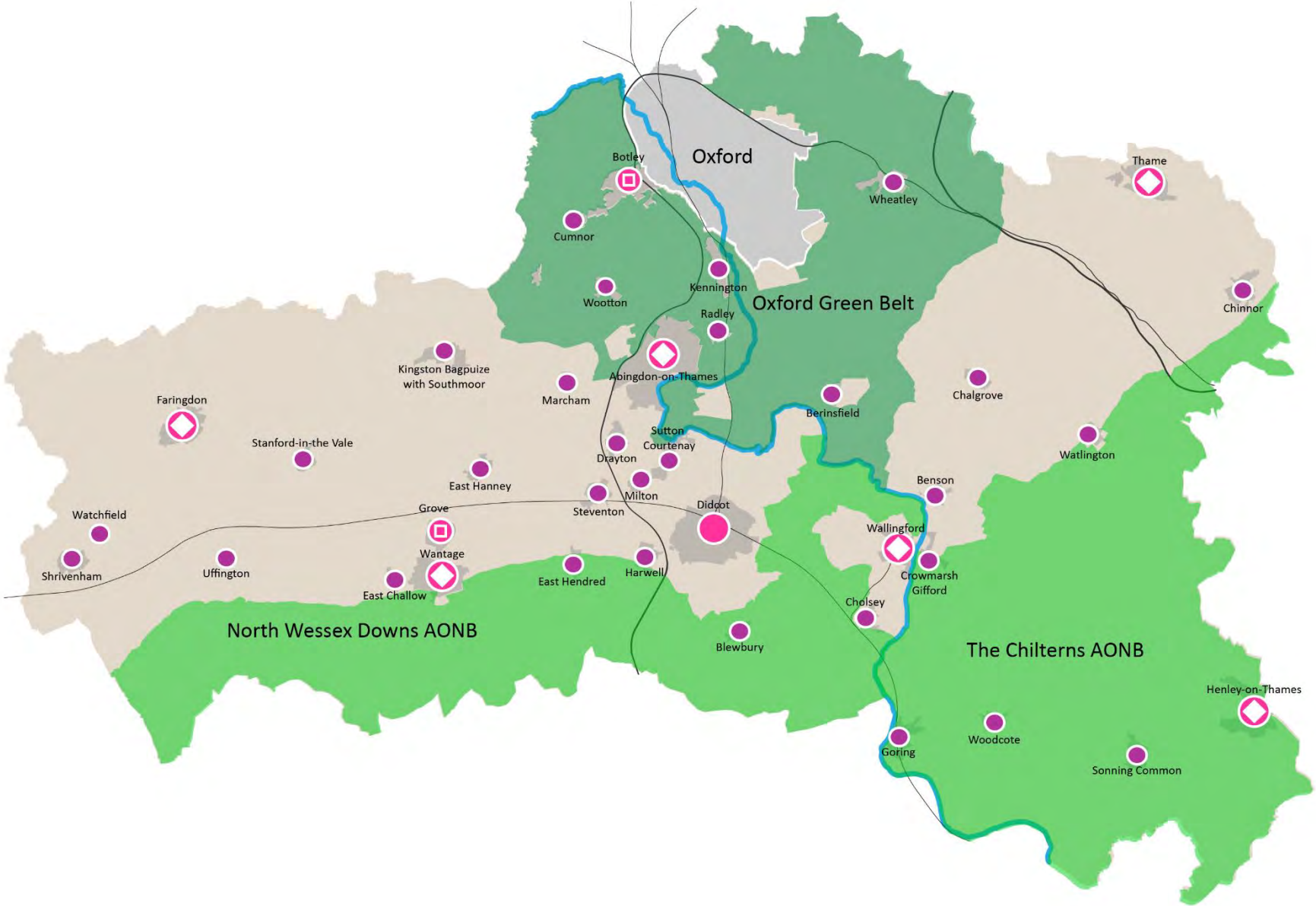
For related information see:

[South Oxfordshire and the Vale public GIS website](#)

Key:

-  Market town
-  Town
-  Local service centre
-  Villages
-  AONB (Area of Outstanding Natural Beauty)
-  Green Belt
-  River Thames
-  Rail and road

Settlements and designations map for South Oxfordshire and the Vale



Landscape character areas

Goal: Understanding the districts

Landscapes and their character reflect the relationship between people and place and are a key part in forming the setting to our everyday lives and the natural environment. These landscapes are extremely important to the districts, they are part of their cultural heritage. With high quality planning, design and management they offer an opportunity to provide a link between people and place. A sensitive, informed, and integrated approach should be taken to conserve, enhance, restore and create landscapes that are attractive, diverse and publicly valued, showing that environmental, social and economic benefits can go hand in hand.

For related information see:

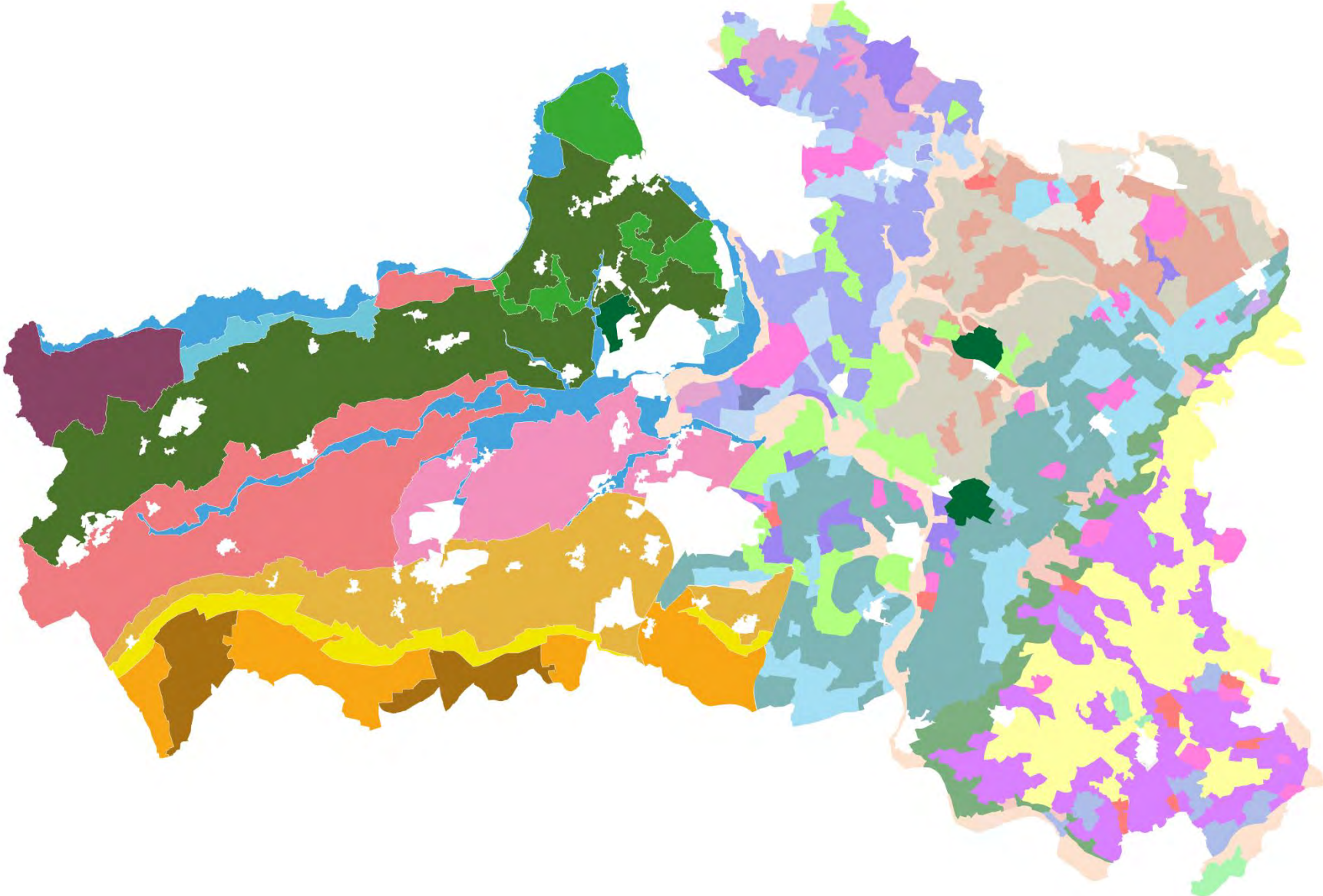
[South Oxfordshire and the Vale public GIS website](#)

Key:

- Downs Open Farmland
- Downs with Woodland
- Downs Scarp
- Downs Footslopes
- Corallian Limestone Ridge with Woodland
- Wooded Corallian Limestone Ridge
- River Floodplain
- River Valley Floor

- Lower Vale Farmland
- Upper Vale Farmland
- Upper Vale with Woodland
- Former Airfield / MOD sites
- Amenity landscapes
- Commons and heaths
- Enclosed escarpment
- Flat floodplain pasture
- Flat open farmland
- Flat semi-enclosed farmland
- Floodplain wetland
- Institutions
- Minerals/ Landfill sites
- Open dip slope
- Open escarpment
- Open farmed hills and valleys
- Open rolling downs
- Parkland and estate farmland
- Lower Vale Farmland
- Upper Vale Farmland
- Upper Vale with Woodland
- Former Airfield / MOD sites
- Amenity landscapes
- Commons and heaths
- Enclosed escarpment
- Flat floodplain pasture
- Flat open farmland

Landscape character map for South Oxfordshire and the Vale



Neighbourhood plan areas

Goal: Understanding the districts

Neighbourhood plans form part of the statutory development plan. They are prepared by local communities to develop a shared vision for their area. Their aim is to shape, direct and help to deliver sustainable development at a community level.

When designing you should refer to the relevant Neighbourhood plan for that area (if the area has a plan adopted) and use the plan to inform your design process. Neighbourhood plans can contain design policies. These should be followed unless material considerations indicate otherwise.











Below is a map of all the current neighbourhood plan areas for South Oxfordshire and Vale of White Horse districts. To see the current neighbourhood plans and their status click on the map below. To see more information about South Oxfordshire and Vale Neighbourhood planning see:

Neighbourhood planning: [South Oxfordshire](#)

Neighbourhood planning: [Vale of White Horse](#)

For related information see: [South and Vale public GIS website](#)

Key:

-  No Plan
-  Plan Preparation
-  Preparing for Submission
-  Independent Examination
-  Plan Made
-  Plan Review - Preparation
-  Plan Review - Pre-submission Consultation
-  Plan Review - Independent Examination
-  Plan Preparation Paused
-  Applied for Area Designation

The neighbourhood plan map is regularly updated. Please visit our [website](#) for more information.

Understanding the site's features and its setting

Goal: Identify the site's features and its context

1. One of the first things to consider before designing a development is to look beyond the red line of the application site. This is the site context. To do this you should undertake a contextual analysis, which will then be submitted to support your pre-application enquiry or planning application.
2. A contextual analysis identifies the context within which the application site is set. This should consider the structure and history of the settlement and landscape in which it is located or relates to, the character of the landscape, biodiversity, the streets and spaces and the built form (all these elements constitute local character). The level of detail in the analysis should be proportionate to the scale and complexity of the development proposal and the sensitivity of the area.
3. Each site feature identified provides an opportunity to shape your design, even where they may initially appear to limit what you are able to achieve. Imaginative solutions to incorporate off-site and on-site features can give developments a unique character and form the basis of your design rationale. You should identify and take account of off-site and on-site features at the outset of the design process as there is rarely opportunity to successfully retrofit a design at a later stage. There should be a clear drawing trail showing how the design of the development has evolved. If the site identifies important habitat connectivity features (watercourses, tree lines, hedgerows, other swathes of linking habitat), this should influence any early framework design.



Figure 1: Illustrative example of a constraints and opportunities plan (major example)



Figure 1a: Illustrative example of a constraints and opportunities plan (minor example)

Developing a design rationale

Goal: Use the site's features and context to shape your design

4. A design rationale is an explanation of the reasons behind the design decisions you make. Developing a design rationale is important; it is the basis for discovering workable and imaginative design solutions and provides justification for them.
5. When developing a design rationale, think about whether there is something from the site and its setting that can enhance place-identity. Landform, habitats, archaeological features, registered parks and gardens, etc., all provide elements that design can be based upon and inspired by. Focus your design rationale on creating a sense of place.
6. When thinking of creating character areas within a development, move away from notional character areas. Instead, use existing site features to inform where different character areas may naturally occur. Create a narrative around place-identity and the spaces defined by the features of the site (for example, there may be a brook or a village green on a site that has historical value which you may want to draw upon). Do not tightly define character area boundaries but make sure to have a gradual transition between them. Focus on the character of the streets/area as a way of creating attractive and defined spaces.
7. Developing a design rationale is a preliminary step within the design process. Design rationales are influenced by the overall design process, they develop and adjust based on the research and detail provided by further steps. They should be flexible and take consideration of emerging issues and technical detail; they should always aim for high quality and sustainable design outcomes and demonstrate this through supporting work and documentation.



Figure 2: Develop a design rationale based around the site's features, opportunities and constraints (major example)



Figure 2a: Develop a design rationale based around the site's features, opportunities and constraints (minor example)



View from Uffington towards Faringdon



Abingdon town centre market square



View from Thames river towards Culham cut



Thame town centre market square

Steps

Inform your design:

Prepare a **contextual analysis** that identifies the local character of the application site and its wider context. This should consider the structure and history of the settlement within which the site is located, or which it relates to, as well as the character of the landscape, biodiversity, streets, spaces and the built form.

Prepare technical studies including (but not limited to) surveys on landform, watercourses, trees, habitats, species, etc.

Agree the scope of a landscape and visual impact assessment/appraisal with the local authority. The assessment should be proportional to the scale of the development and the sensitivity of the site and its setting.

Communicate your design:

An **opportunities and constraints plan** with a clear key;

A **concept plan** with a clear key;

A **Framework plan**.

Support your design:

[Building for a Healthy Life \(2020\)](#)

[South Oxfordshire District Council's Developer's Guidance on Air Quality](#)

[Vale of White Horse District Council's Developer's Guidance on Air Quality](#)

[South Oxfordshire Conservation Area Appraisals](#)

[Vale of White Horse Conservation Area Appraisals](#)

[Didcot Garden Town Masterplan \(Chapter 9 A masterplan for Didcot Garden Town, 2017\)](#)

[South Oxfordshire District Council Landscape Character Assessment \(2017\)](#)

[Vale of White Horse Landscape Character Assessment \(2017\)](#)

[Chilterns Building Design Guide](#)

Design principles

A contextual analysis including an opportunities and constraints plan (which will inform your design rationale) of the wider and immediate site context has been prepared. It identifies the following both within the site and beyond the site boundary:

- 1.1 One of the first things to consider before designing a development is to look beyond the red line of the application site. This is the site context. To do this you should undertake a **contextual analysis**, which will then be submitted to support your pre-application enquiry or planning application.
- 1.2 One of the first things to consider before designing a development is to look beyond the red line of the application site. This is the site context. To do this you should undertake a **contextual analysis**, which will then be submitted to support your pre-application enquiry or planning application.
- 1.3 Existing networks of natural features, including watercourses, trees, woodland, hedgerows, green spaces, field patterns, habitats and public rights of way (footpaths, bridleways, etc.);
- 1.4 The landscape character and topography highlighting visually prominent areas;
- 1.5 Attractive and/or sensitive views and skyline (both of and from built and natural features) into, out of and within the site;
- 1.6 Buildings and structures of historical importance including listed buildings, associated setting and historic views, historic landscape pattern and features (historic landscape character), conservation areas, historic parks and gardens and archaeological remains;
- 1.7 Any statutory designations such as National Nature Reserves, AONBs, Green Belt, and Sites of Special Scientific Interest (SSSIs) amongst others, and non-statutory designations such as Ancient Woodland, Dark Skies, valued landscapes and Registered Battlefields, amongst others;
- 1.8 Potential barriers to development such as railway lines, major roads, utilities, pipelines, noise, pollution, land contamination, flooding, etc., and any resulting easements including those specified in the Local Plan(s);
- 1.9 The settlement structure of the site and surrounding area: this includes studying the historical development of the settlement, its townscape; structure and hierarchy of streets, spaces, facilities, existing connections (including public rights of way and cycle routes), gateways, nodes, density, plot and block sizes. Figure ground diagrams can help explain a settlement structure;

1.10 The land uses adjacent to the site and how these will impact on the design/treatment of the edges of the development - identify how each edge of the development site will address the adjacent uses;

1.11 The streets and public spaces surrounding the site, the enclosure of streets and public open spaces, the layout and form of spaces and the public and private interface;

1.12 The built character: the scale, form and massing of the built environment, treatment of building frontages and boundaries, building types and materials. This should all be included in a Character Study.

*Note: All design principles are applicable to all scales of development unless otherwise specified; *minor applications, **major applications*

Natural features and resources

Goal: Working with and enhancing the natural features and resources of the site

8. The landscape and settlement character of South and Vale are varied and get their identity from natural settings and historical development. New development should respect and respond to this unique landscape character including its setting and views, share common characteristics with its locality and reinforce local identity, as well as providing well-designed landscapes.
9. The contextual analysis, including the constraints and opportunities plans, should be used to inform the layout of the site to ensure it works with and enhances the natural features and resources of the site.
10. The site layout should respect its physical features and those of its adjacent land including its landscape character, topography, orientation, landform, geology, drainage patterns, field patterns/boundaries and vegetation cover. You should use these resources positively in association with the physical features to benefit the intended users of your development and ensure that it does not have a negative impact on neighbouring land use
11. If a site is to be developed for renewable energy generation, the site contours and the extent of levelling and regrading works required to facilitate the development should be considered. This should be discussed as part of any pre-application and detailed within any planning application, based on topographical survey plans. Wherever possible such developments should utilise previously developed land, brownfield land, contaminated land, industrial land or agricultural land preferably of classification 3b, 4 or 5. When development is proposed on agricultural land it is desirable for the applicant to propose a project end date to demonstrate the temporary nature of the project.
12. Technical studies will show you whether there are any physical features that need protecting- this should include views, water features, existing vegetation, biodiversity or ecological value, heritage assets and setting. This technical information is needed to inform your design and support your application.
13. The site layout should include features that contribute to the green infrastructure, which can include existing features such as vegetation, water courses, areas of natural habitat and proposed features such as public open spaces, community orchards, structural planting, and Sustainable Drainage Systems (SuDS). Improving access to meaningful green spaces as well as their scale and quality is important for health and wellbeing.



Figure 3: Identify, retain, and enhance the green infrastructure and natural features as part of a scheme (major example)



Figure 3a: Identify, retain, and enhance the green infrastructure and natural features as part of a scheme (minor example)



Tree planting in public square (Abingdon)



Clusters of trees planted in public open space (Tadpole Garden Village)



Tree lined streets and formal planting (Milton Park)



High value trees incorporated into open space (Aston Rowant)

Steps

Inform your design:

Provide technical studies including (but not limited to) surveys on trees, habitats, species, biodiversity metric assessment, landscape character and visual assessment/appraisal, historic appraisals, etc.

Communicate your design:

Prepare a Landscape Strategy that sets out the development's landscape including details on how the existing landscape and biodiversity features will be retained and incorporated into the site layout and the intended function and management of proposed features (e.g. how high are the hedges allowed to grow?);

Demonstrate how the features of Sustainable Drainage Systems (SuDS), e.g. retaining ponds and swales will be integrated into the development's landscape.

Support your design:

National Landscape Character Area profiles (Natural England, 2014)

An approach to Landscape Character Assessment (Natural England, 2014)

Guidelines for Landscape and Visual Impact Assessment (Landscape Institute, 3rd ed. 2013)

Historic Landscape Character (Oxfordshire County Council, 2016)

South Oxfordshire District Council Landscape Character Assessment (2017)

Vale of White Horse District Council Landscape Character Assessment (2017)

South Oxfordshire & Vale of White Horse District Councils Green Infrastructure Strategy (2017)

Planning guidance for the development of large scale ground mounted solar PV systems (bre 2013)

Chilterns AONB Management Plan (2019-2024)

North Wessex Downs Management Plan (2019-2024)

The SuDS Manual (CIRIA, 2015)

North Wessex Downs Dark Skies

Design principles - Natural Environment

Ensure the scheme:

2.1 retains and strengthens the site's landscape features; using the physical features of the site and results of technical studies positively and imaginatively in its design:

- A Landscape and Visual Impact Assessment or Landscape and Visual Appraisal is undertaken, appropriate to the scale and the sensitivity of the site as set out in Guidelines for Landscape and Visual Impact Assessment (GLVIA);
- Reference should be made to any relevant national, county, district, and neighbourhood Landscape Character Assessments and how the site conforms to or differs from these. The particular character of the site and immediate surroundings should be recorded to pick up other characteristics that may be important in considering the effects and the design of the proposal;
- The Landscape and Visual Assessment work should be used to inform the design of the development, so that possible effects are identified at the outset and design responses have been implemented as an integral part of a scheme, such as modifications to siting, access, layout, buildings, structures, ground modelling and planting;

- The North Wessex Downs and the Chilterns Areas of Outstanding Natural Beauty (AONB) cover large areas of land within the districts. Their Management Plans and associated documents should be applied to any proposals within the AONB or their setting.

2.2 retains and creates views in and out of the site to prominent landscape features and landmarks;

2.3 is designed to maximise the benefits of natural resources (utilising landform, orientation, geology, and natural drainage patterns) and does not negatively impact on the benefits enjoyed by neighbouring properties and spaces;

2.4 implements SuDs (Sustainable Drainage Systems) as an integral part of the development's open space network. SuDs should be designed into the development from the outset with features such as: wetlands, basins, ponds, scrapes, swales, retention planters (rainwater gardens), combined with good landscaping to make a positive contribution to the biodiversity, character and appearance of a development;**

- 2.5 creatively integrates and enhances historic landscapes (such as agricultural patterns or historic battlefields) and the survival of archaeological remains and features (refer to Historic England scheduling selection guide);
- 2.6 has a joined-up network of open spaces which form an integral part of the development and are located where existing and new residents can access them easily, not just located on the edge of the development (or where there is left over space) and must be useable;**
- 2.7 provides a variety of natural and designed landscapes for everyone, that is accessible, with different functions to suit a diverse range of needs;**
- 2.8 does not use landscape as a barrier between new and existing development and is therefore integrated into the settlement (unless there is strong justification to create a landscape buffer, for instance to reduce the impact of road/rail noise, to retain gaps between settlements or link open spaces);

- 2.9 identifies noise, smells, air quality and contaminated land sources (e.g. sewage treatment works, railway line, a ring road, etc.) to inform the orientation and location of a development and responds to it positively. If land is not suitable for development due to amenity issues, play space and most public open space should not be located in these areas.

*Note: All design principles are applicable to all scales of development unless otherwise specified; *minor applications, **major applications*

The value of trees within the built environment

Goal: To understand the value trees can bring to all developments and integrate them properly to enhance the scheme

14. Trees in all developments are important and have multiple benefits to all of us and to our natural environment. Not only do they enhance the character and appearance of an area, increasing the draw of the area to local visitors and tourists, there is clear evidence that properties on a tree lined street will have a greater financial, social, and environmental value than those without (TDAG No trees, No future, 2010).
15. Trees and hedgerows, individually and collectively, can make an important contribution to biodiversity and the landscape. They also absorb atmospheric pollution and have a beneficial influence on the climate. Development proposals should provide a net increase in tree canopy cover where this is possible, having regard to other considerations including site size, heritage protection, landscape character, habitat protection and compatibility (e.g. turning priority habitat grassland into a plantation woodland would not be suitable), residential amenity, and the need to make the best use of land.
16. The environmental benefits are significant. Trees can assist with climate control through air cooling in summer months, filtering pollutants, improving air quality, and absorbing carbon dioxide. They can also play a key role in reducing surface water flooding and provide valuable habitats and movement corridors for wildlife. The social and cultural elements of our lives can be enhanced by the presence of trees. They can form attractive features to our outdoor areas for recreation, the backdrop for relaxing and the inspiration and visual relief along our busy transport routes. It is proven that having access to trees and meaningful green spaces is vital for good mental and physical health at all ages.
17. The retention of appropriate mature trees within a development can add a valuable sense of maturity to a scheme. Mature trees will visually soften what can otherwise be a harsh development until new planting is established. Incorporating existing trees into public open space as a focal point in a development will achieve the most benefits, providing a community hub and a sense of connection with nature. Trees should be planted at an early stage to allow them to grow naturally, helping to soften the appearance of a development over time in a sustainable way.

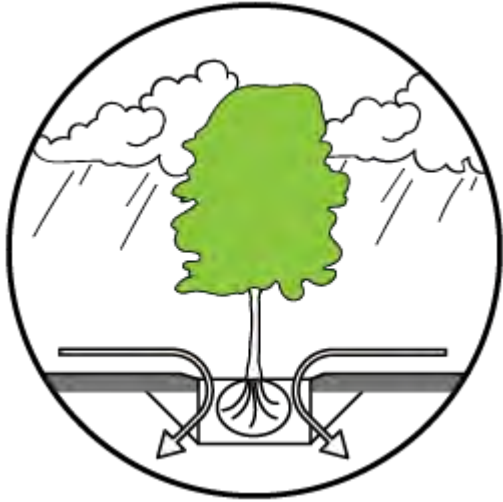
Figure 4: The positive contributions of tree planting in the built environment



Planting in a development proposal

Goal: Use planting to help a development integrate into the landscape with its own character and sense of place

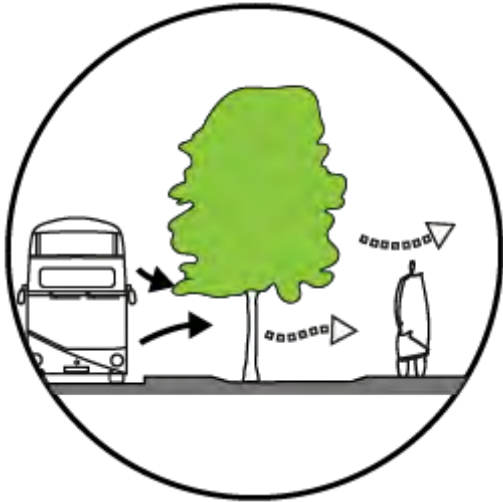
18. New planting can have multiple uses, such as defining the character of an area, or creating soft boundaries with hedgerow planting, improving the visual appearance and provide resources for wildlife, or being part of Sustainable Drainage Systems (SuDS) and traffic calming measures, whilst providing a wider range of benefits.
19. It is essential that all landscaping is designed in coordination with all of the above and below ground utilities infrastructure including lighting. This will avoid conflicts that would prevent the planting from being implemented and maximise long term benefits. It is key that during the design stage, sufficient space both above and below ground is provided for the requirements of tall growing and large canopied trees to be incorporated into the layout. Such trees are essential to help mitigate the effects of climate change, provide long-term softening and integration of the development.
20. Trees should be planted for the long-term so that they can grow to maturity and deliver their benefits. This means that they need sufficient soil volume to grow in. To make this possible, integrated, joined-up thinking and planning is essential so that the use of space both below and above ground is properly thought through and coordinated. Avoid relying only on planting trees in private gardens where their future cannot be secured.



Tree pits hold rainwater for sustainable drainage



Trees help remove carbon from the atmosphere



Trees can provide a windbreak and shading in the public realm



Clusters of trees provide natural habitats

Figure 5: Design considerations and wider benefits of planting in the built environment

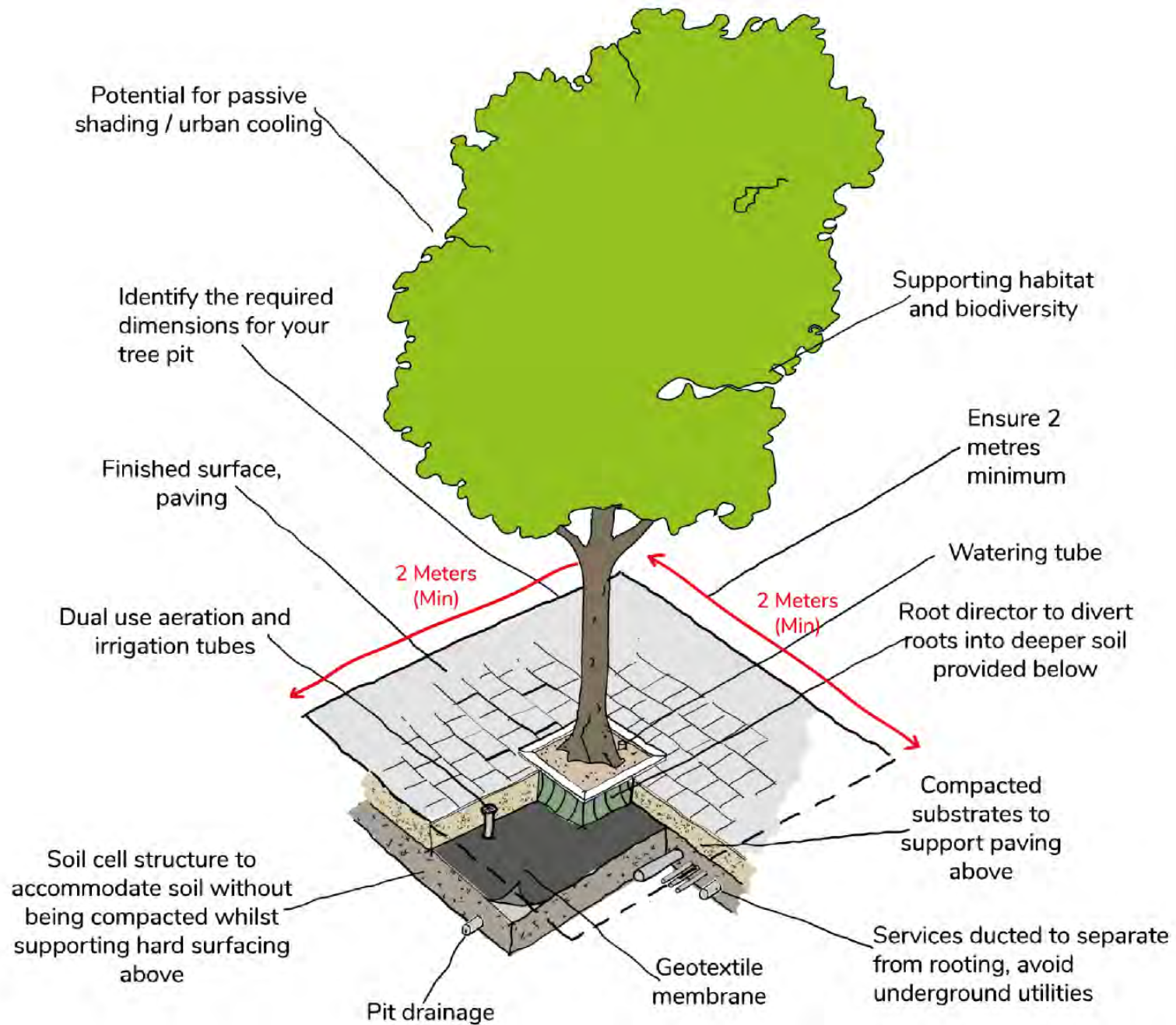
Planting is your asset

21. Tree planting schemes should use a range of species, sizes and regular spacing corresponding to the nature and hierarchy of the street. Main streets will need to be of sufficient width to incorporate large, canopied trees set well back from buildings. Designing a site layout around green spaces allowing for the future growth potential of the planting scheme will enable the landscape to mature to its full potential and be a key feature of the development. Tree planting should be of a scale to grow above the roof line to help soften and assimilate development on the long term.
22. Seeing your planting scheme as an asset that can add value to a development will encourage a holistic design approach. Larger growing tree species should be used where possible as the benefits they provide are much greater, with relatively little installation cost.
23. Make the most of your planting by designing tree planting for dual use, such as creating or enhancing a certain landscape character to a development, as well as being a key component of a drainage system - this is a good use of resources.

Aftercare and maintenance

24. A key tool to ensure the successful establishment of a planting scheme is aftercare and maintenance programmes, such as a Landscape Management Plan. Seeing your planting scheme as an asset that is worth caring for with simple measures will ensure it achieves its full potential, successful establishment, and a return on your investment.
25. It is essential to have a budgeted management programme in place to monitor and maintain new plantings on their journey to establishment. Failure to establish new plantings prevents the delivery of their benefits.

Figure 6: Generic principles to be addressed when designing a tree pit. Professional guidance should always be sought from a range of professionals. Structure tree pits to ensure sufficient soil volume, in a hydrated, aerated and uncompacted form. Investment required at the design stage to ensure the correct tree rooting environment is achieved during implementation and establishment stage. Increasing benefits when tree reaches maturity in a healthy state.



Design principles - Planting in a development proposal

Make sure:

2.9 New planting including trees are designed appropriately into the layout. This should be explained in the landscaping strategy, and where applicable, complete and submit the following documents with your application:

- a topographical survey;
- a Tree Survey in accordance with BS 5837
- an Arboricultural Impact Assessment produced in accordance with BS 5837;
- an Arboricultural Method Statement, including a Tree Protection Plan in accordance with BS 5837

2.10 all landscaping is designed in coordination with all other above and below infrastructure, including utilities, visibility splays, highway layouts, drainage, etc.;

2.11 the planting scheme including tree planting scheme uses a range of species and sizes, appropriately spaced to correspond to the nature and hierarchy of the street or open space and suited to the site's soil type. A mix of species is required with no more than 20% of any genus and no more than 10% of a particular species on the site. This is to improve the biosecurity, wayfinding, and seasonal interest;**

2.12 the scale of planting should also relate to its potential function as mitigation for landscape impact. Tree planting should be of a scale to grow above roof lines to break up areas of development and to help assimilate development into the landscape setting;

2.13 a landscape management plan has been prepared and submitted which explains the aftercare and maintenance programmed for the landscaping.**

*Note: All design principles are applicable to all scales of development unless otherwise specified; *minor applications, **major applications*



High value trees incorporated into open space (Great Western Park)



Retained trees around open space (Sutton Courtenay)



Clusters of trees planted in edge of development
(Great Western Park)



Tree and soft planting integrated along swale (Didcot)

The value of biodiversity within the built environment

Goal: Working with and enhancing biodiversity for future generations

26. South and Vale are rich in biological diversity (“biodiversity”). Biodiversity underpins our relationship with the natural world and is key for our own wellbeing, from human health to food production. Historic and modern declines in biodiversity mean that bold action is required to not only minimise impacts but ensure that ecosystems are left in a measurably better state than they were before. It is essential that the masterplanning and design process acknowledges existing biodiversity assets, understands the environmental context of those assets and takes steps to deliver tangible net gains for biodiversity.

27. Developers should engage with competent ecological advice and undertake ecological surveys at the earliest opportunity. This will ensure that the masterplanning and design process is informed of all biodiversity assets on site and integrates strategies for delivering biodiversity net gain. Developers are encouraged to engage with the local planning authority through pre-application advice to discuss how their development can deliver biodiversity net gain.

Key ecological considerations

28. There are key biodiversity assets that must be understood and considered during the masterplanning and design process of any development. These are:

- Habitats and features of increased ecological value, especially irreplaceable and priority habitats;
- Species assemblage, especially protected species and priority species;
- Sites formally designated for their nature conservation value – Special Areas of Conservation (SAC), Site of Special Scientific Interest (SSSI) , Local Wildlife Sites (LWS), etc.;
- The baseline contribution that the existing site makes towards biodiversity. This will influence the amount of biodiversity net gain that a development can deliver.

29. The biodiversity mitigation hierarchy should be applied to all developments. These required steps should be taken to avoid impacts where at all possible, mitigate when impacts cannot be avoided; and finally compensate for any residual impacts.

30. Impacts can be direct (e.g. loss of habitats to development) or indirect (e.g. increased footfall resulting in deterioration of habitats). Developers will be expected to identify and justify impacts against the biodiversity mitigation hierarchy.

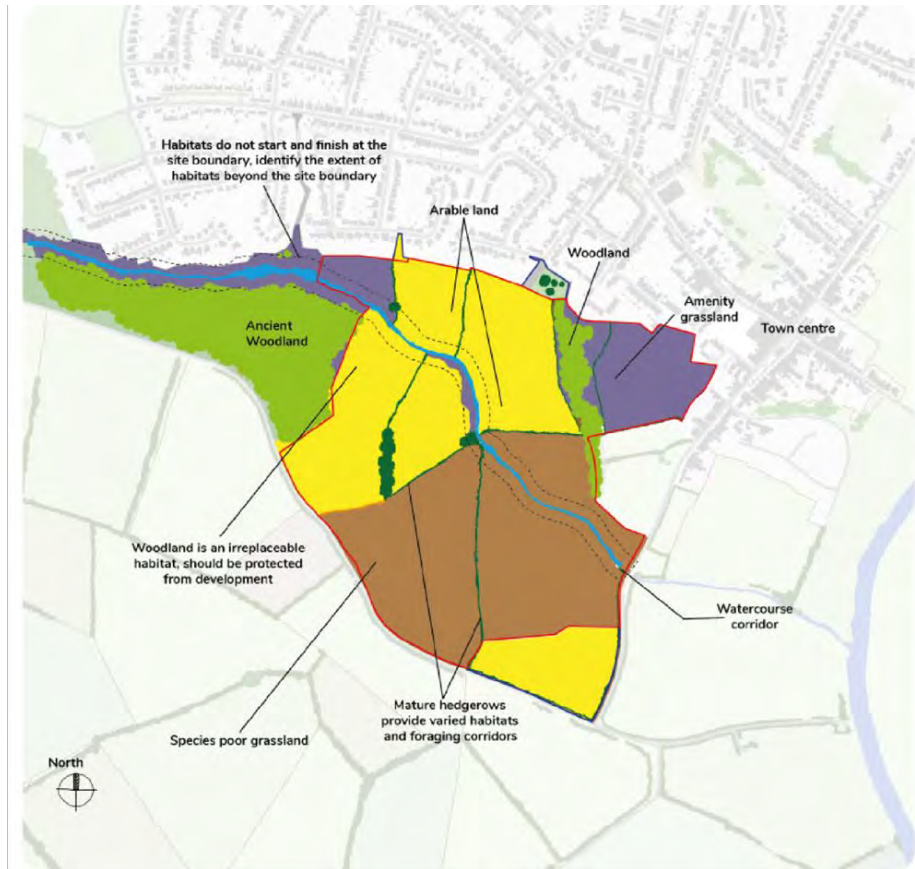


Figure 7: Illustrative example identifying biodiversity and habitats (major example)



Figure 7a: Illustrative example identifying biodiversity and habitats (minor example)

Biodiversity Net Gain

31. Biodiversity net gain is an approach to development and land management that leaves biodiversity in a measurably better state than before. This approach is required by the Environment Act 2021, national policy and the districts' local plans. Developments that result in net losses of biodiversity are not acceptable. Biodiversity metrics are used to quantify and compare the anticipated biodiversity value of a site before and after development has taken place. Throughout the masterplanning and design process, biodiversity metrics should be used to ensure that developments remain on-track to deliver a biodiversity net gain. The local planning authority has produced guidance on the appropriate use of biodiversity metrics and the evidence base needed to support any assessment. Pre-application advice is available for developers to engage with the local planning authority and review biodiversity metrics prior to the submission of an application.
32. Where proposals fail to achieve a net gain, the Council will seek amendments to the scheme to avoid impacts and/ or, to increase the level of mitigation so that the proposals can demonstrate a net gain. Where net loss is demonstrably unavoidable, the Council will require the developer to provide offsite compensation offsetting or other compensation measures are not appropriate for dealing with impacts on protected species, irreplaceable habitats, or designated sites. In circumstances where net gain cannot be adequately demonstrated and compensation proposals are inappropriate or inadequate, the Council may refuse planning permission.
33. Where on site biodiversity enhancements are agreed as part of a planning permission these will be secured through planning conditions and obligations.
34. On site biodiversity enhancements must be looked at holistically and coordinated with other site proposals especially the landscape and drainage strategies to ensure that they can be implemented without compromising other elements of site design (for example, wildflower grasslands are not compatible with small urban spaces).
35. Built environments, if designed and implemented appropriately, can become valuable areas for wildlife. Proposals should seek to integrate biodiversity enhancements throughout areas of development by providing biodiverse landscaping and faunal features. It is strongly recommended that at least 50% of new structures should have at least one faunal enhancement feature (bat box, bird box, bee brick, etc.) integrated into the built fabric. In many cases it will be appropriate to integrate multiple features into a single structure. Faunal enhancement features should be provided in suitable positions. For example, bat boxes should be integrated into the southern or western elevations of structures where thermal gain is maximised. Bird boxes should be integrated into eastern and northern elevations, facing away from prevailing weather. Both should be located high up, no less than three metres above the ground level.



Example of a bug hotel providing additional habitat



Watercourses are primary habitats



Wildflower meadows provide butterfly habitats



Watercourses are primary habitats

Steps

Inform your design:

Undertake a preliminary ecological appraisal to understand the extent of species and habitats across the site

The survey will also highlight key features present in the landscape such as ancient trees, ponds, and other water bodies.

Communicate your design:

Provide habitat plans and use these to demonstrate how development complies with the biodiversity mitigation hierarchy;

Use pre-development and post-development habitat plans to inform required biodiversity metric assessments;

Ensure biodiversity enhancement plan proposals are included and coordinate with the landscape strategy.

Support your design:

[BS 42020:2013 Biodiversity - Code of practice for planning and development](#)

[BS 8683:2021 Process for designing and implementing Biodiversity Net Gain](#)

[Guidelines Ecological Impact Assessment in the United Kingdom and Ireland - CIEEM, 2018](#)

[South and Vale Biodiversity Metric Guidance \(2021\)](#)

[Improving access to greenspace: A new review for 2020 \(Public Health England \(2020\)\)](#)

[Environment Act 2021](#)

[Guidance Note 8 Bats and artificial lighting GN08/18](#)

Design principles – Biodiversity

Ensure the scheme:

2.14 retains and enhances existing important habitats, creates new habitats and aims to deliver at least 10% Biodiversity Net Gain (Environment Act 2021)¹;

¹Mandatory biodiversity net gain is scheduled to come into force in November 2023.

2.15 provides comprehensive and up-to-date ecological surveys, undertaken by a suitably qualified ecologist and in accordance with industry best practice. Results of surveys should be used to inform the design proposal;

2.16 where impacts on ecological receptors (designated sites, protected species, priority habitats, etc.) are predicted, explains what those impacts are and how the design process has complied with the biodiversity mitigation hierarchy. This means firstly avoid impacts where possible,

2.17 mitigate unavoidable impacts and finally compensate residual impacts to deliver a net gain. Make sure that integrated measures are clearly shown on plans;

2.18 demonstrates that your development will deliver a net gain for biodiversity using a biodiversity metric;

2.19 demonstrates biodiversity enhancement proposals are compatible with the site design including the landscape and drainage strategy.

*Note: All design principles are applicable to all scales of development unless otherwise specified; *minor applications, **major applications*

Creating a network

Goal: A place that is easy to get to and move through for all users

36. When creating a network of paths and streets, remember that these are some of the most permanent features of our built environment. The street network needs to cater for different modes of transport and different users.

37. Designers are always keen to promote sustainable transport choices. Through design, we can encourage people to make more active and sustainable transport choices. There is often a misconception that the best way to prioritise walking and cycling is by restricting the movement of cars, using cul-de-sacs for example. However, this commonly results in a more engineered, car dominant environment. It is also land inefficient and causes confusion and frustration. Connected environments work best for all users and all modes of transport. In designing, when we refer to all users, we mean everyone who could live, work, or visit the development. This includes people with disabilities, parents, carers, pregnant women, children and older people.

38. Prioritising walking and cycling should be addressed as part of the design of the streets rather than simply reducing the connectivity of the development. By avoiding cul-de-sacs, you will provide people choice of movement. By offering options for movement, traffic gets dispersed. Think about different users' experience as they travel through the site (e.g. blank façades or rear boundaries in the public realm do not provide an attractive experience from a pedestrian point of view). Think about who your users are and how they are likely to use the space throughout the day.

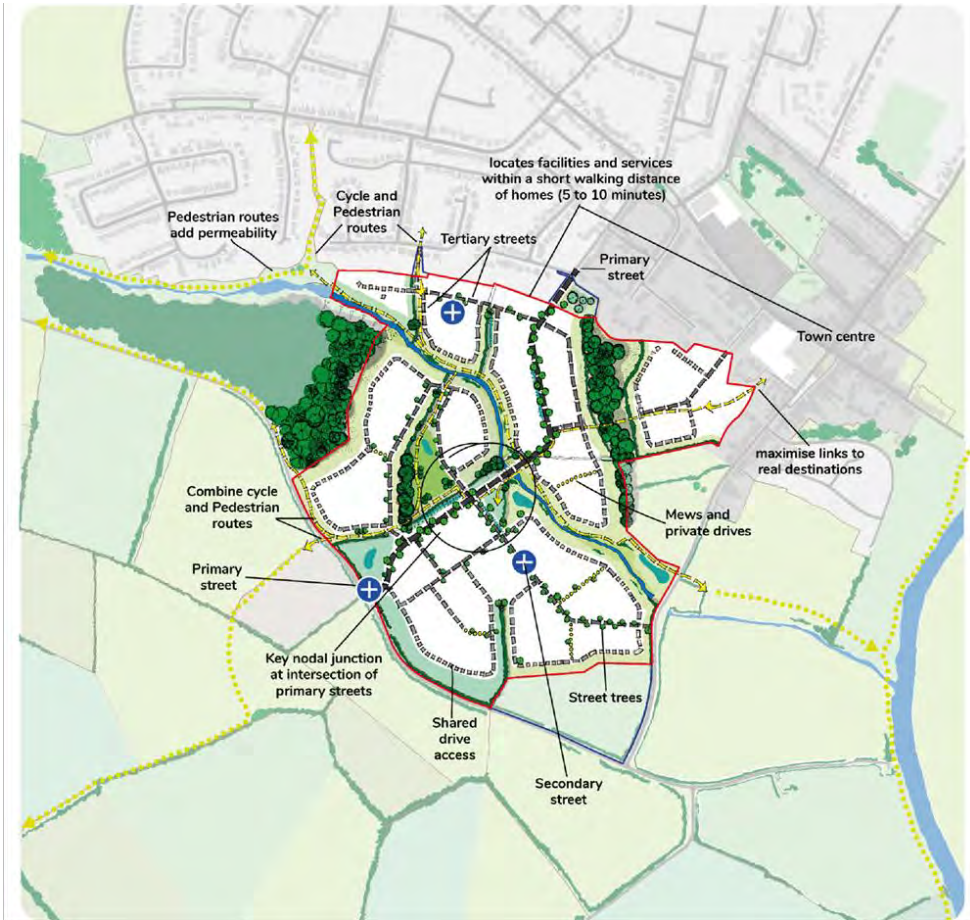


Figure 8: Develop a clear movement strategy and street hierarchy (major example)



Figure 8a: Develop a clear movement strategy and street hierarchy (minor example)

Defining a network

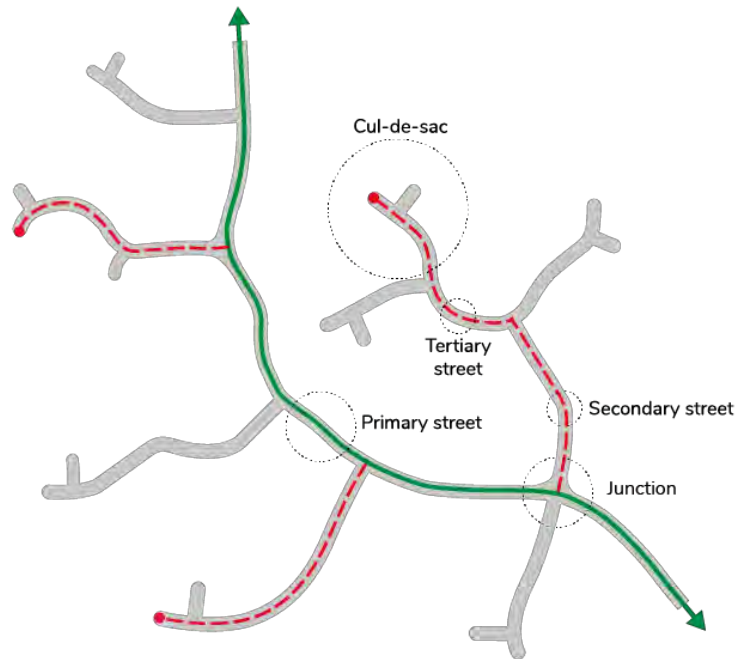


Figure 9: A disconnected network provides little choice and often results in longer routes between desired locations

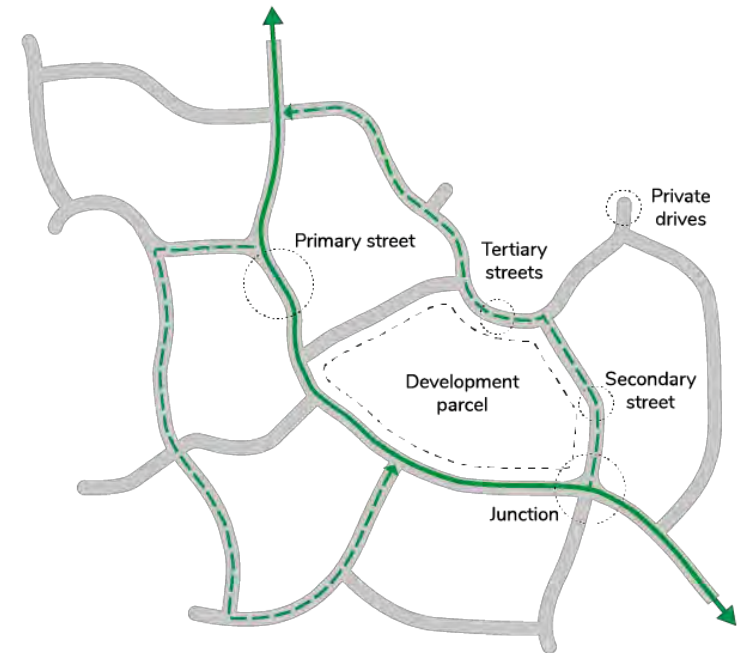
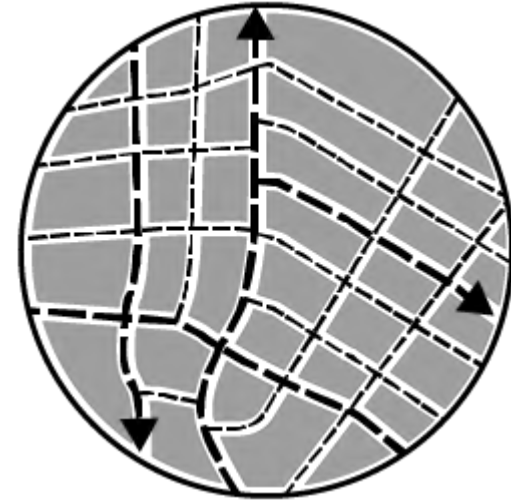


Figure 10: A connected network provides multiple choices and often results in shorter routes between desired locations

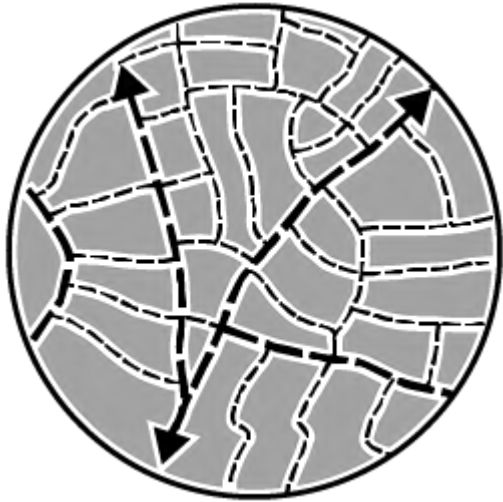
Identifying street patterns



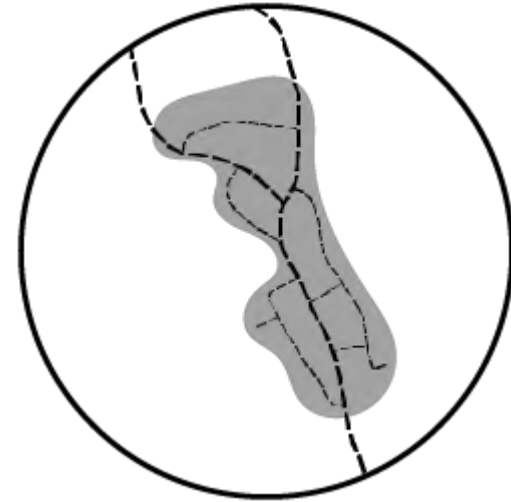
Organic / historic street pattern



Semi-formal street pattern



Formal street pattern



Other street patterns

Figure 11: Street patterns

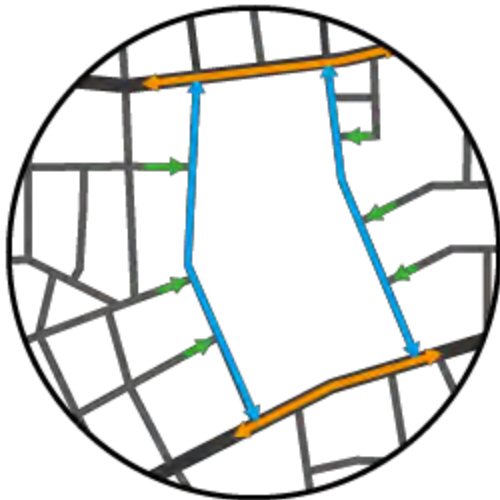
Working with street patterns



Locate site



Design street pattern within the site



Identify existing street pattern



Ensure development retains character and permeability

Figure 12: Providing a network of connected streets



Traditional tree lined street (Nuneham Courtenay)



Provide routes and infrastructure for cycling and pedestrians



Retain green routes and links



Shared surface and tree planted boulevard (Didcot)

Steps

Inform your design:

Identify the travel characteristics of the existing site, including pedestrian and cyclist movements and infrastructure;

Locate existing public transport provision, including provision/frequency of services, location of bus stops/train stations, park-and-ride facilities;

Identify the classification of the highway network in the vicinity of the site.

Communicate your design:

Provide a Transport Statement and accompanying plan;

Prepare a Transport Assessment following an appropriate scale of transport survey in relation to the scale of development;

To see whether your proposal requires a Transport Statement or Transport Assessment check the thresholds found in Appendix 1 of Oxfordshire County Council's Transport for New Developments, Transport Assessments and Travel Plans (2014).

Support your design:

[Manual for Streets 1 \(DfT, 2007\)](#)

[Manual for Streets 2 \(ICHT, 2010\)](#)

[Oxfordshire Streets Design Guide \(Sep 2021\)](#)

[Building for a Healthy Life \(2020\)](#)

[Designing Shared Space, \(Landscape Institute, technical Information Note, 2019\)](#)

[Local Transport Note 1/20 Cycle infrastructure design \(Department for Transport, 2020\)](#)

[Oxfordshire County Council Transport for New Developments: Transport Assessments and Travel Plans March \(2014\)](#)

[Sustrans, Walking and cycling infrastructure design guidance](#)

[Sight Line: Designing better streets for people with low vision \(DC, CABE 2010\)](#)

Design principles - Movement and connectivity

Ensure the scheme:

- 3.1** has a network of streets or paths/integrated cycleways that connect with each other; creating an attractive choice of routes for all users and all modes of transport (20-minute neighbourhood); prioritising the needs of pedestrians, people with disabilities, cyclists, equestrians and public transport users over the needs of motorists within the network;
- 3.2** has a clear and logical order of street, (often referred to as a 'street hierarchy') that use a range of street types. These can be identified by their differing features including their width, enclosure, frontage, parking arrangements, how connected they are to each other, range of uses, landscaping and materials;
- 3.3** connects to existing streets, cycle and walking paths (including public rights of way), creating direct, safe (consider surveillance, sight lines, lighting) and attractive links for all users whilst avoiding 'cul-de-sac' layouts. Where applicable avoid single point of access (particularly for large developments);
- 3.4** provides links to neighbouring allocated land that could be developed in the future making them an integral part of the street network and hierarchy;
- 3.5** provides direct pedestrian and cycle links to local services and facilities that are convenient and follow natural desire lines, and uses the features identified in the opportunities plan to create visually interesting and attractive routes;
- 3.6** maintains priority for pedestrians and cyclists, designing people-friendly spaces;
- 3.7** locates facilities and services within a short walking distance of homes (800 m) and provides easy access for existing and new residents;
- 3.8** provides bus stops within a five-minute walk (400m) of homes, is preferably 600m from a primary school and 1500m from a secondary school, and where possible, close to local services and facilities;**
- 3.9** includes wherever possible accessible wayfinding/signposting to be installed to promote movement on foot/bike/active travel.

*Note: All design principles are applicable to all scales of development unless otherwise specified; *minor applications, **major applications*

The design of streets

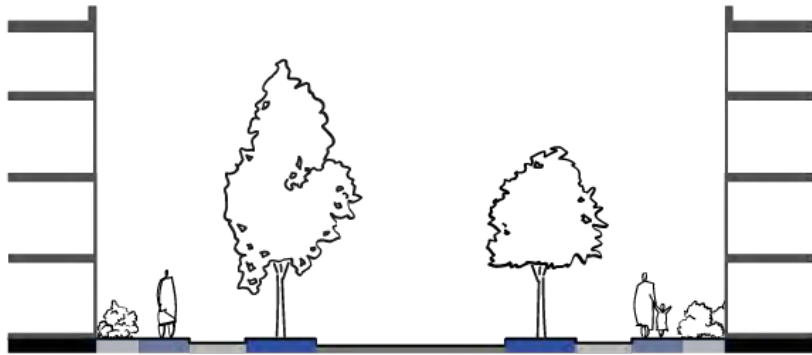
Goal: Attractive streets and spaces defined by buildings rather than the highway

39. Designers often talk about the definition and enclosure of streets and spaces. This simply means how the height and width of the buildings and the gaps between them relate to the width of the street or space in front of them and the buildings on the other side.
40. Enclosure is mostly created by a strong building line but also by well-defined boundaries and street trees. You can also use enclosure to create variety and visual interest with subtle changes in street widths, building heights, and street angles. This can help an attractive street scene unfold at a human scale and provide opportunities to surprise and delight with these changes.
41. The boundary treatment between public and private spaces can take many forms including planting, hedges, railings, walls and fencing. Sometimes it is appropriate to have a physical barrier, for example, the change from public to private space can be shown by a change in materials. Your choice of boundary treatment should reflect the high-quality treatments used in the local area. It is important to provide a clear distinction between public and private space.

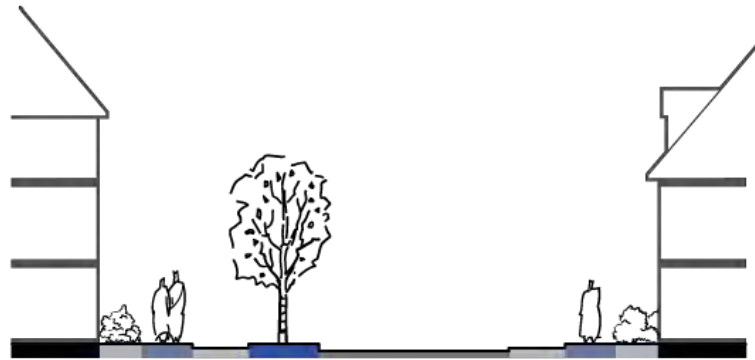


Figure 13: Street types, scale, proportion and enclosure define a space

Primary streets



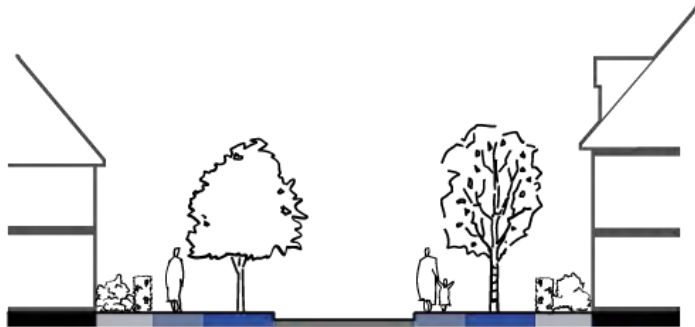
Primary street with tree planted verges and segregated cycle lanes



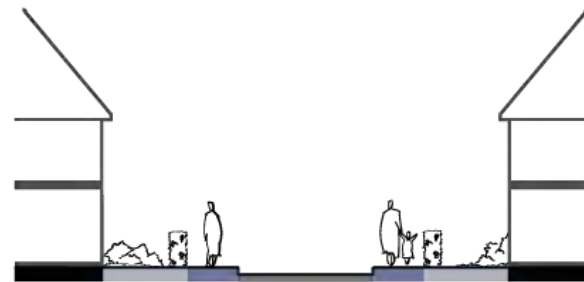
Primary street, alternative arrangement with tree planted verge and integrated cycle lane

Figure 14: Examples of primary streets incorporating tree planting and cycle lanes

Secondary streets



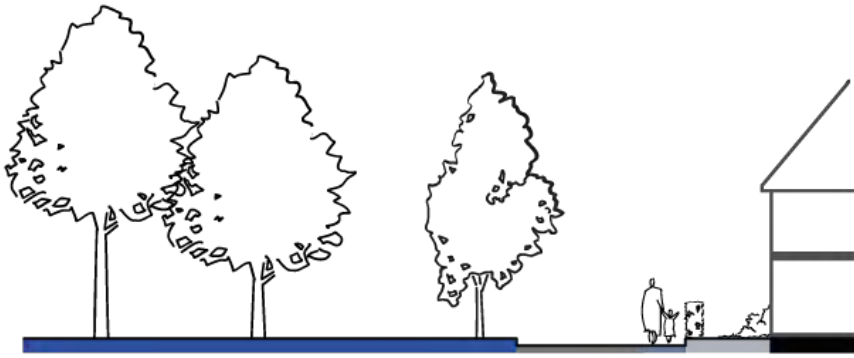
Secondary street with tree planted verges and segregated pathway



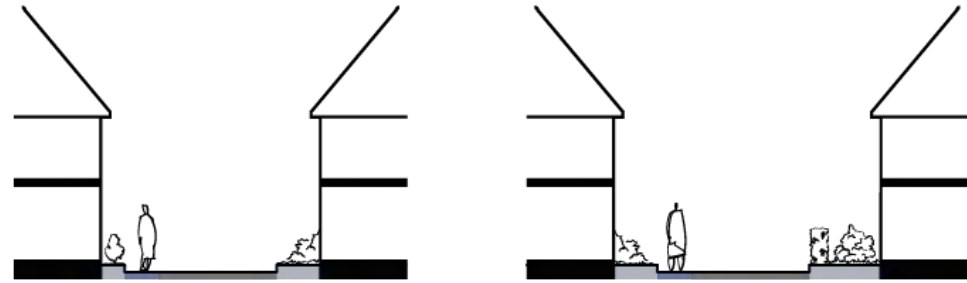
Secondary street no verge or tree planting, alternative arrangement

Figure 15: Examples of secondary streets incorporating tree planting

Tertiary streets and mews



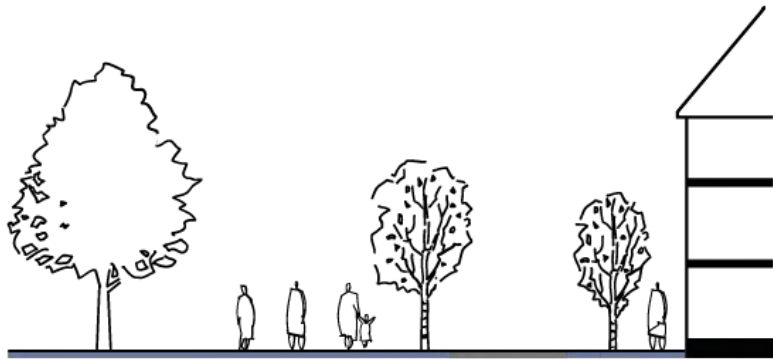
Private drive, facing open space



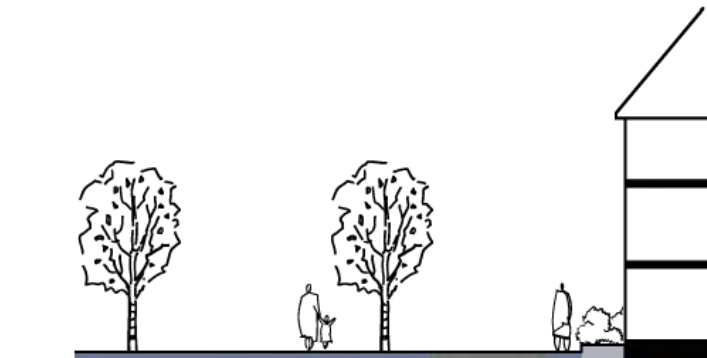
Standard mews (left) and green mews (right)

Figure 16: Examples of tertiary streets including private drives and mews

Streets and shared surfaces



Shared surface street, verge with tree planting



Shared surface street, soft landscaping / planting

Figure 17: Examples of shared surface streets incorporating tree planting and landscaping



Enclosed streets provide good definition of space



Private drives integrated with landscaping (Didcot)



Streets as part of the public realm (Abingdon)



Shared surface lanes with landscaping (Didcot)

Steps

Inform your design:

Assessment of street definition and enclosure in the local area; the measurement of building heights and street widths and the continuity of buildings along the streets (the gaps between buildings and their distance from the street edge).

Communicate your design:

Demonstrate how the definition and enclosure of the streets and spaces reflect that of the local area;

Prepare a plan showing the location of all active frontages, and key buildings;

Provide details of the boundary treatment to be used including the height.

Support your design:

[Oxfordshire Streets Design Guide \(Sep 2021\)](#)

[Building for a Healthy Life \(2020\)](#)

Design principles - The design of streets

Ensure the scheme:

- 3.9** has streets where buildings and landscaping rather than the highway (including parking) are visually dominant;
- 3.10** encourages movement by prioritising the needs of pedestrians, people with disabilities, cyclists and public transport users, over the needs of motorists within the design of streets. Applicants should refer to Manual for Streets 1 (2007) and 2 (2010);
- 3.11** includes trees and soft landscaping that create character and distinction between street types. The species provided must be appropriate to the environment and their location, both at the time of planting and maturity and; therefore, provide adequate space for soil volume to allow root growth and for canopy growth;
- 3.12** demonstrates that the long-term maintenance and management of landscape elements has been considered through a management and maintenance plan;
- 3.13** does not result in a conflict between street trees, their location or planting requirements, drainage and street lighting. Engage with the County Council's highways department and adoptions team early to ensure an overall high quality masterplanning and design approach;
- 3.14** designs residential streets to a maximum speed of 20 mph and integrates natural methods of traffic calming within the street design (i.e. landscape-led traffic calming);
- 3.15** avoids tarmac and uses porous materials for non-adopted roads and pavements (consider non-slip paving);
- 3.16** provides continuous and generous footpaths to meet the needs of all users (including the visually impaired), including dropped kerbs and gradients, and to allow enough room for wheelchairs and pushchairs to be used safely and comfortably (minimum of 2m width);
- 3.17** considers shared services/home zones on lower order streets and/or local centres, next to public spaces, or other appropriate locations. When designing shared surfaces, incorporate permeable paving, consider tactile/colour contrast material details to cater for visually and mobility impaired people;
- 3.18** has incorporated and designed social spaces, providing places for people to shade and shelter, rest, gather, interact, and spectate therefore contributing to health and wellbeing.

*Note: All design principles are applicable to all scales of development unless otherwise specified; *minor applications, **major applications*

Streets as spaces

Goal: Streets as spaces designed for everyone where people can rest, gather, and socialise

42. Streets and spaces are the public face of our towns and villages where people walk, meet, rest, and interact. They are also often the most permanent features of our built environment. An attractive public realm enhances people's quality of life and the perception of a place.
43. The quality of our streets and spaces can be undermined by overly engineered traffic calming measures such as speed humps and featureless build-outs such as chicanes. This type of traffic calming is unattractive and can be frustrating for all transport modes. Natural methods of traffic calming can include narrowing down the carriageway, use of planting and build outs to incorporate street trees, use of on-street parking, change of colour/materials, use of shared surfaces, varying the alignment of the vehicular route and use of tight junction radii while considering access for emergency services and refuse vehicles. When designing turning areas, think of imaginative solutions as they do not always need to be formal. Also remember that Sustainable Drainage Systems can be incorporated into street designs and used imaginatively to provide unique features that help identify a specific order of street or signal an important route through a site.
44. If you design for the elderly, children, women, parents or disabled people, you are designing for all. This is inclusive design. An inclusive street is the street that meets the needs of people from early to later life. Inclusive design covers age, ability, gender, race or income. Research has shown that sensory-rich environments are places that attract a diverse range of visitors and have benefits for disabled people - particularly those with sensory impairments such as visual impairment or learning disabilities. Provide a range of opportunities for people to engage with a place through their senses (e.g. visual, scent, touch and sound of street).
45. The design and location of street furniture needs to be considered as part of the early stages of the design process. It should also respond to the character of the area. Think carefully about the multifunctional role that street furniture can have and how it can enhance existing character and create new character.

46. Design with all users' needs in mind. The regular spacing of street seating on pedestrian routes to facilities should be provided to allow all people the opportunity to rest (in particular, think about the elderly, pregnant women, and disabled people). To keep the amount of street furniture to a minimum the functions they perform can often be combined. For example, street trees can be protected by a circular bench.



Figure 18: An attractive public realm enhances people's quality of life and the perception of a place



Figure 19: An attractive public realm enhances people's quality of life and the perception of a place.



Swale frontages as part of a street (Upton)



Varying surface materials and landscaping, enhancing shared surfaces (Tadpole Garden Village)



Landscaping to soften street scene (Didcot)



Traffic calming and landscaping at a human scale (Upton)

Steps

Inform your design:

Assessment of street definition and enclosure in the local area; the measurement of building heights and street widths and the continuity of buildings along the streets (the gaps between buildings and their distance from the street edge).

Use your Movement Strategy to inform the detailed design of your streets. Make sure that the design of a street reflects its order in the street hierarchy.

Seek advice from appropriate professionals (landscape and tree specialists) who can provide advice on what species might be appropriate for your development.

Communicate your design:

Demonstrate how the definition and enclosure of the streets and spaces reflect that of the local area;

Prepare a plan showing the location of all active frontages, and key buildings;

Provide details of the boundary treatment to be used including the height;

Prepare a plan and sections showing the features of each street/order of street and how they work together to create different types of social spaces, including appropriate trees, soft landscaping and street furniture;

Explain how appropriate traffic speeds will be achieved and indicate where natural methods of traffic calming have been integrated into the street design, where needed.

Support your design:

[Manual for Streets 1 \(DfT, 2007\)](#)

[Manual for Streets 2 \(ICHT, 2010\)](#)

[Oxfordshire Streets Design Guide \(Sep 2021\)](#)

[Building for a Healthy Life \(2020\)](#)

[Streets for all \(Historic England, 2018\)](#)

[WHO Environmental Noise Guidance \(Executive summary 2018\)](#)

[Oxfordshire Transport and Access Group \(OXSTRAG\)](#)

Design principles - Streets as spaces

Ensure that streets as spaces are:

- 3.9** fronted by main entrances/front doors which provide direct access to the street or space known as 'active frontage';
- 3.10** providing 'natural surveillance' by incorporating ground and first floor habitable room windows overlooking the street;
- 3.11** defined by boundaries that reflect the character of the area and clearly differentiates public space from private space;
- 3.12** providing sufficient amounts of space between the public realm and adjacent/adjoining buildings, known as 'semi-private' space.
- 3.13** the amount of street furniture is kept to a minimum to: reduce street clutter, and simplify navigation. Furniture should be of high quality, well-designed, robust, and in keeping with its setting;
- 3.14** all users' needs have been considered through inclusive design. Careful consideration is given to the safety and comfort of mobility and visually impaired people. Reflect upon the need for: shade and shelter, seating for rest stops, and consider gradients. Include wayfinding and signage installations, natural surveillance;

3.15 where they are required, the use of bollards is avoided in favour of other treatments, such as tree planting;

3.16 that lighting features follow the design approach used for other street furniture and avoid causing light pollution in sensitive/darker non-urban rural areas (consider, downward lighting and reduce LUX levels in these areas). Direct glare must be avoided, from any lighting scheme to neighbouring properties;

*Note: All design principles are applicable to all scales of development unless otherwise specified; *minor applications, **major applications*

Framework and structure

Goal: Use an appropriate scale and density to create a place of human scale

47. The appropriate size for a perimeter block should strike a balance between adequate provision for amenity space and parking, while allowing a permeable street pattern for all modes.
48. Density should be appropriate to the location and respond to and/or enhance the character of the existing settlement. For larger development proposals, a range of densities, building types and forms will be required. Increased densities should be focused on key movement intersections, along strategic routes, where public transport facilities are provided, overlooking public spaces, or within the geographical centre of neighbourhoods, communities and villages. This varied density profile adds character and interest, supports local facilities and public transport and can provide the building mass to create strong framing of public spaces.
49. Successful communities require a full range of local services and facilities, including commercial, live-work, educational, health, spiritual and civic uses. These need to be conveniently sited and connected to residential areas by safe routes. Facilities are to be clustered around a high-quality public realm or public space, as a central focus. This could range from a village green or, a small public square, to a simple widening of the street.

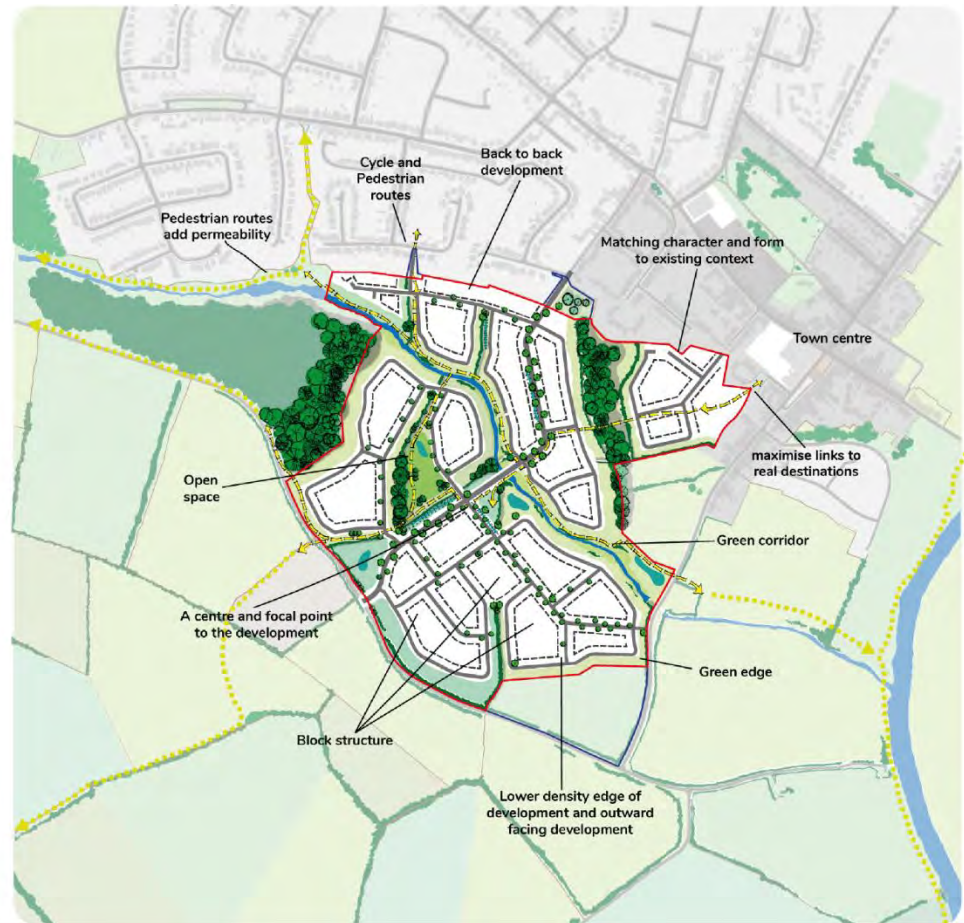


Figure 20: Establishing structure and a framework of parameters (major example)



Figure 20a: Establishing structure and a framework of parameters (minor example)

Identifying patterns of development



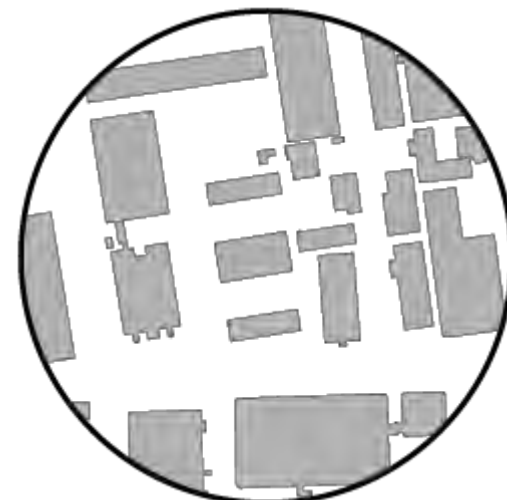
Historic (organic) pattern



Dispersed (cul-de-sac) pattern



Perimeter block pattern



Commercial/industrial pattern

Figure 21: Identifying the structure of an area, its density and character

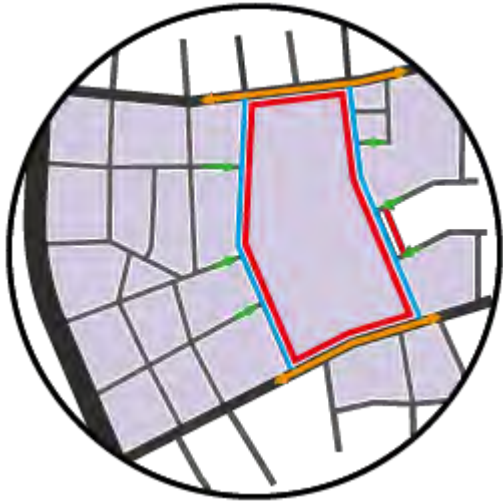
Working with block structures



Locate site



Identify block structure



Work with existing densities



Ensure development retains structure and character

Figure 22: Understanding and working with specific block characteristics and densities

Applying structure and density

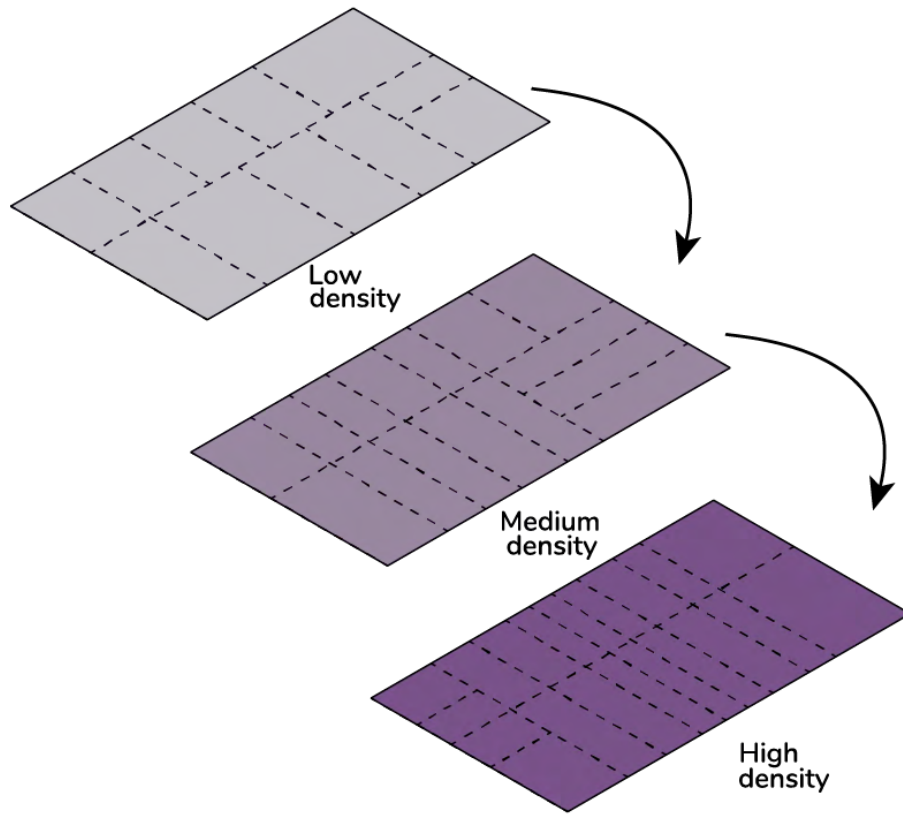


Figure 23: Setting out blocks and defining density, density is considered as the quantity of dwellings within a set (measured) area.



Figure 24: Design example of perimeter blocks



An historic core, more dense and compact development structure (Faringdon)



Countryside edge (Sutton Courtenay)



An historic village core (Wheatley)



An historic core, more dense and compact development structure (Abingdon)

Steps

Inform your design:

Identify the existing **grain (pattern of development)** in the vicinity of the site;

Identify the **density** of existing development in the vicinity of the site;

Characterise the general **type and tenure of properties** in the vicinity of the site.

Communicate your design:

Provide a plan indicating the **existing pattern and scale** of development within the relevant context of the scheme;

Prepare a statement on **density**, setting out how the development makes an effective use of land;

Provide a plan showing the **distribution of uses**, as well as the mix of house types and tenures. It is useful to also prepare a table showing the following information;

Provide a plan showing the **location of landmark buildings and focal points**;

Provide a plan showing the walking routes and related **distances to local facilities and services** (not 'as the crow flies').

Support your design:

[National Design Guide \(2019\)](#)

[Building for a Healthy Life \(2020\)](#)

[Oxfordshire Strategic Housing Market Assessment \(2013\)](#)

Design principles - Framework and structure

Ensure the scheme:

- 4.1** uses a range of appropriate densities that do not detract from the character of the local area and uses land effectively. Increased density is focused around key movement intersections, along strategic routes, and overlooking public spaces, or within neighbourhood, community, and village geographical centres. Higher density sustainable developments are encouraged;
- 4.2** has a mix of local services and facilities, uses, housing types, and tenures that meet local and district needs and are justified in terms of planning policy and viability;
- 4.3** consists of perimeter blocks that respond to the grain of the existing settlements taking cues from block sizes, plot patterns, and the relationship between built and open space;
- 4.4** back-to-back distances are a minimum of 21 metres between facing habitable rooms; back to boundary a minimum of 10.5 metres; back to side a minimum of 12 metres; front to front a minimum of 10 metres. Where these distances are not met, demonstrate how the design proposals ensure that privacy is maintained. These distances may not be sufficient when adjacent uses are of a sensitive nature (i.e. school, hospital, nurseries, leisure and recreation, etc.);
- 4.5** places landmark buildings and focal points in prominent locations that help people to navigate;
- 4.6** provides a sense of enclosure appropriate to the street hierarchy and to achieve a human scale;
- 4.7** positions buildings to make the most of daylight and sunlight, wherever possible, and provide a sun angle diagram to illustrate how this would be achieved;
- 4.8** addresses the edges of the site in a positive way by facing properties outwards and not placing side and rear fences next to the open space or open countryside. Applicants (where applicable) will be required to demonstrate how their proposals provide a positive edge with a clear and well-defined external image;
- 4.9** considers the existing plot pattern. If smaller than the Design Guide standards, develop to stated standards; if it is bigger, proportionally match the existing plot pattern (where development is adjoining);

4.10 provides a clear distinction between private and open space. Boundary treatments between private and open space or open countryside can take many forms including: planting, hedges, walls, and fencing. The chosen boundary treatment should reflect the character of the area whilst being secure and of high quality. Depending on the adjacent land use, estate railing/stock proof fencing and hedge planting may be appropriate;

4.11 avoids awkward or vulnerable corners within the design proposal to ensure land efficiency, and a clear definition of public and private space.

*Note: All design principles are applicable to all scales of development unless otherwise specified; *minor applications, **major applications*

Plots and amenity

Goal: Provide usable amenity spaces for all residents

Internal amenity space

50. Developers and applicants should have regard to the space standards set out in the Government's Planning Practice Guidance, NDSS (National described space standards) when designing internal amenity space.

External amenity space

51. Providing private or communal amenity space in the form of garden spaces, patios, and balconies (that are accessible) is important to achieve a successful and attractive development. All dwellings should seek to provide private or communal outdoor amenity space. This should be appropriate to both the location of the proposal and the type and size of dwelling. Every dwelling should have convenient access to outdoor amenity space. Provision of outdoor amenity space contributes to the wellbeing of the occupants. Amenity space can be provided in the form of a private garden, patio or balcony. Where balconies are provided, these should be generous to encourage use (e.g. enough space for a table and chairs or food and plant growing).

52. Awkward size gardens should be avoided, in order for them to be usable and enjoyed. Consider the orientation of these spaces and sunlight. The scale of plots and their gardens within the context of the development should be considered. New development should be proportional to the size of neighbouring plots, particularly in lower density areas with larger plots and gardens or where adjacent to burgage plots. Ensure that gardens are not overshadowed by outbuildings or garages and maximise light availability. Where no private individual gardens are proposed for apartments, private communal gardens should be provided, normally to the rear of blocks. Take account of existing trees and impacts on shading.

Neighbouring amenity

53. Developers and applicants should be mindful of the impact of the proposals on the amenity of future and existing adjacent occupiers. Proposals should not give rise to unacceptable impact.

Defining plots and amenity

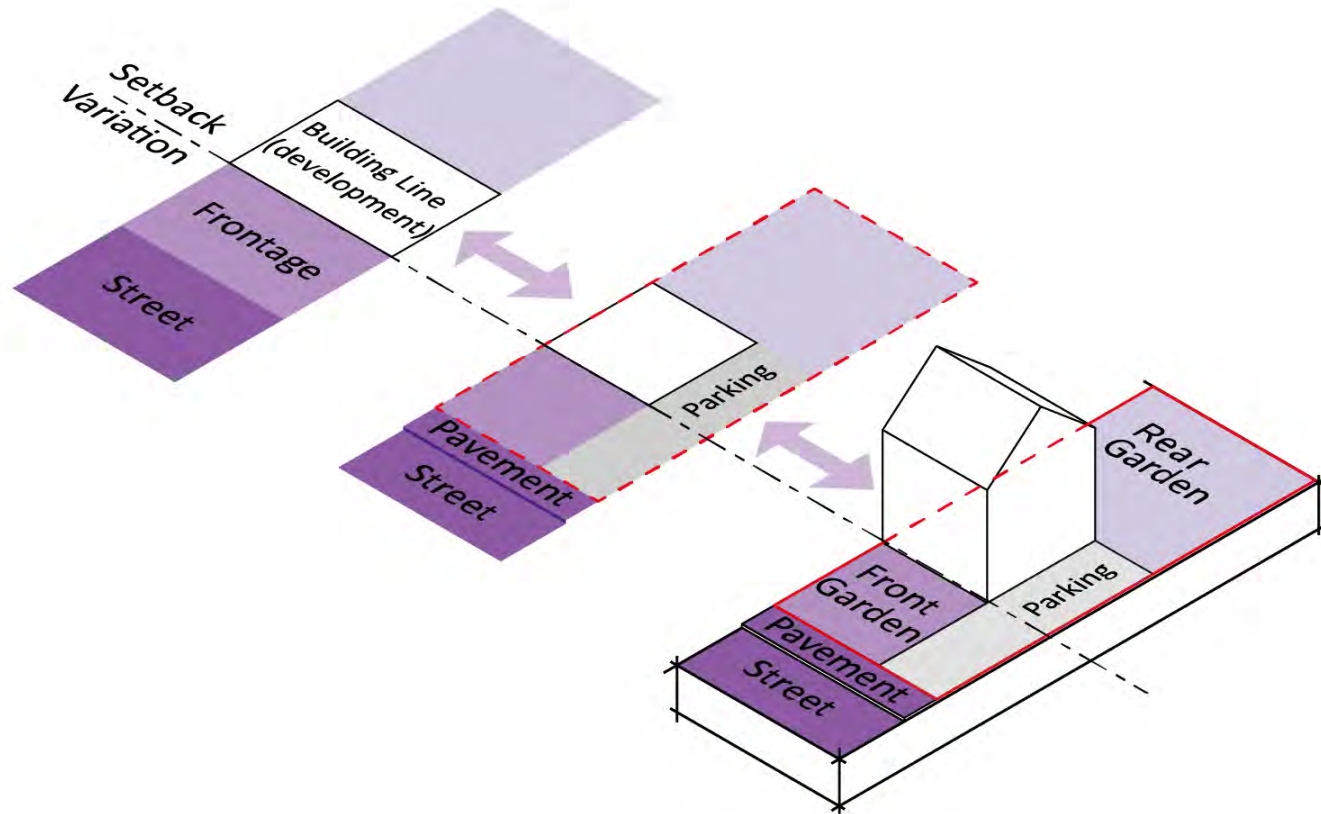


Figure 25: Individual plots are defined by their curtilage (plot boundaries). Their frontage should have direct access onto the street, have a varied setback considering street type and character, a clear building line, and private amenity to the rear or side of the building.

Amenity parameters

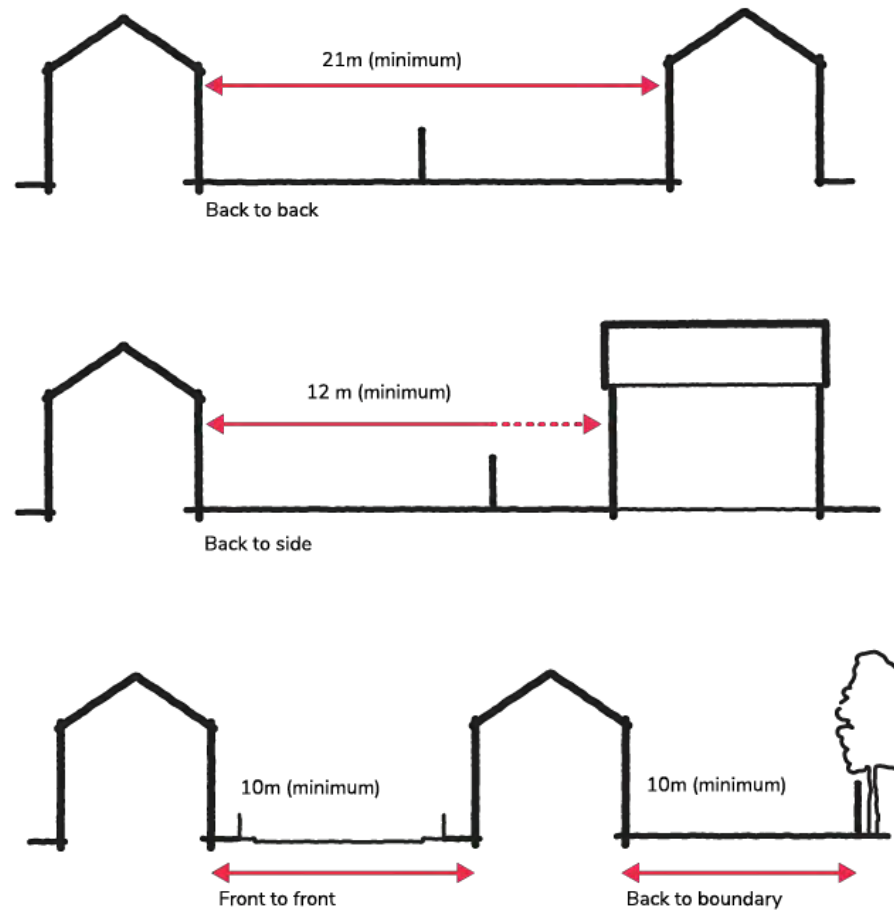


Figure 26: Defining the scale and offset distances for private amenity and plots

Amenity with gradients and level changes

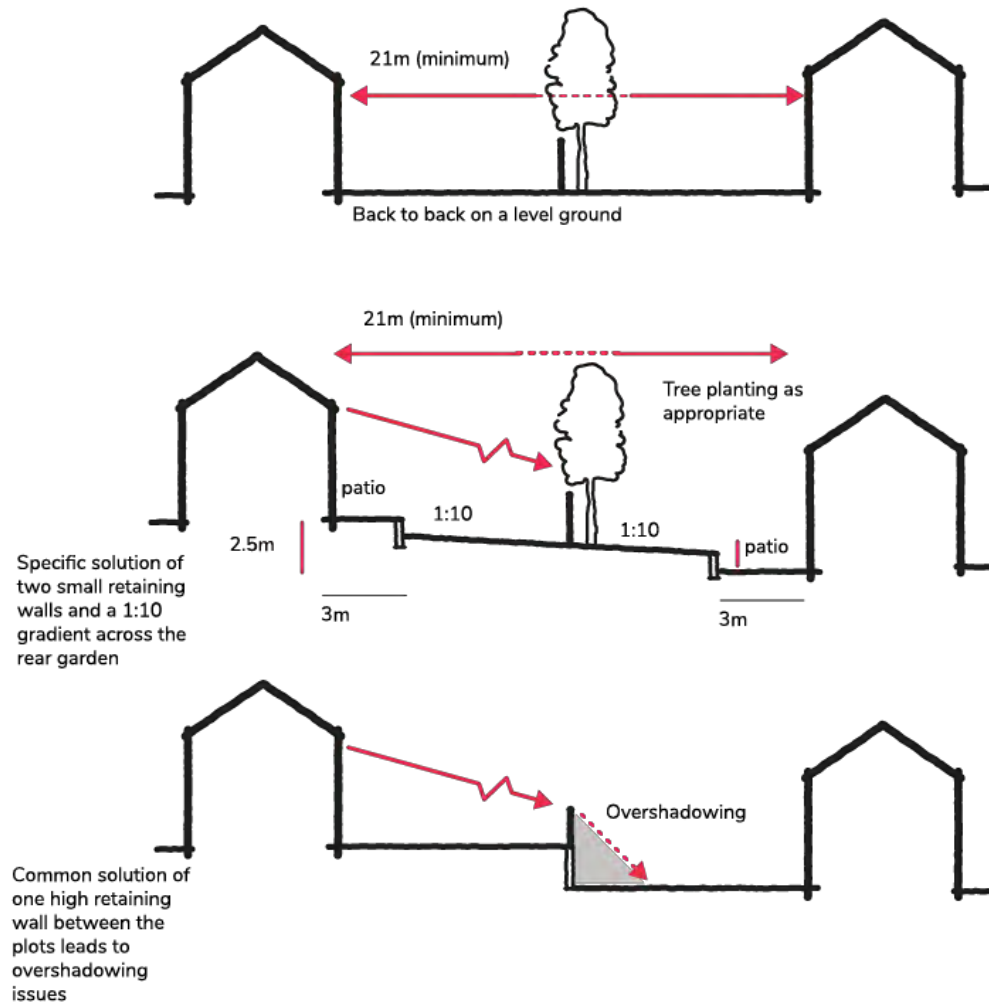


Figure 27: Considering gradients, ground levels and overshadowing when applying amenity parameters



Mixed balconies on apartments (Kings Barton, Winchester)



Landscaped front gardens (Tadpole Garden Village, Swindon)



Larger balconies on apartment corners (Crab Hill, Wantage)



Example of edible gardens in public space (Abingdon)

Steps

Inform your design:

Indicate the size of plots and amenity space as part of identifying pattern and density;

Include technical studies including sun paths (sun angle diagrams) and wind modelling, where appropriate.

Communicate your design:

Prepare a plan indicating what type and size of amenity space has been provided for each residential unit;

Support your design:

[National Design Guide \(2019\)](#)

[National Design Code Part 1: The Coding Process \(2021\)](#)

[National Design Code Part 2: Guidance Notes \(2021\)](#)

[Building for a Healthy Life \(2020\)](#)

[Technical housing standards nationally described space standard \(2015\)](#)

Design principles - Private amenity

Ensure the scheme:

4.11 has an adequate amount of quality private amenity space provided for each residential unit, including apartments, or a robust justification why private amenity space cannot be provided to the standards:

Detached or semi-detached dwellings should have a minimum of:

1 Bed \geq 40 sqm

2 Bed \geq 50 sqm

3 Bed or more \geq 100 sqm

For terraced houses \geq 80% gross internal area in sqm

For apartment buildings \geq 40 sqm of communal shared space¹

¹ this can be achieved through a mixture of balcony space (excluding juliet balconies) where a private balcony achieves 5 sqm minimum (which can be subtracted from the communal space requirement above).

4.12 has gardens that are rectilinear and in the orientation of the buildings flank walls. Awkwardly shaped, or impractical, garden areas should be avoided;

4.13 provides residents of the buildings privacy by providing a sufficient amount of space between public and/or communal spaces and the adjoining buildings, in the form of front gardens (also known as 'semi-private' space). This should be accessible. The size of private amenity space should reflect the prevailing character of the area. These are the general/minimum standards for amenity space to ensure that an adequate amount is provided. Justification should be provided where private amenity space cannot be provided to meet the standards;

4.14 has front gardens that contribute positively to the street scene, and has planted or permeable areas that are no less than 1m in depth on higher order streets. Front gardens should reflect the street hierarchy, density and sense of enclosure;

4.15 comprises amenity space that is not compromised by the location of parking areas and garages. Gardens should not be unduly overshadowed by outbuildings or garages and make the most of the light available;

4.16 has boundary treatments that are informed by a contextual analysis in terms of height, structure and materials. Make sure to maintain a single material boundary treatment along the edge of any curtilage facing a public space. Visible boundary treatments in public areas need to have cohesive treatment and be secure. Close-boarded or panel fencing is generally not an appropriate boundary treatment for prominent locations, such as street frontages. Walls offer a secure option and can be softened with planting. Hedgerow planting is best for frontages and soft boundaries, adding visual appearance and providing resources for wildlife;

4.17 provides direct access from dwellings to gardens (e.g. maisonettes and ground floor apartments).

*Note: All design principles are applicable to all scales of development unless otherwise specified; *minor applications, **major applications*

Storage, servicing, and utilities

Goal: Design in servicing requirements at the outset

54. The quality of our streets and spaces can be undermined by the clutter of bins, bikes, and services if these are not properly designed into the building. Screening and enclosures, which can add to the character of a street frontage, are a useful tool in providing waste storage without detracting from the street scene. The provision and location of utility requirements should be considered at an early stage to minimise potential conflict and reduce the impact. Whilst most utilities run underground, they have an impact on where trees may be planted within the public realm. Those above ground, in the form of supply boxes, can be unsightly. When considering bin storage, imaginative solutions should be considered that incorporate storage as part of the front façade and provide visual screening from the street scene. When designing cycle storage, consider ease of access, as well as bicycle security, to ensure the facilities are used as intended.

General design considerations for waste and cycle storage



Figure 28: Design considerations for bin and cycle storage



Waste and cycle storage solutions



Cycling storage



Example of bin storage area incorporated into elevation
(Tadpole Garden Village)



Bin storage areas should be considered as part of the architecture
(Newhall, Harlow)

Steps

Inform your design:

Indicate the location of bin storage area;

Use your character assessment to inform the design and choice of materials for your bin storage

Communicate your design:

Prepare a plan indicating what type and size of amenity space has been provided for each residential unit;

Prepare a plan showing the location of bin storage areas and collection points and the access provided between the two, including ensuring adequate accessibility to bin storage for those with mobility issues and impairments;

Prepare a plan showing the routes for service vehicles to access each building/ dwelling, also known as a Swept Path Analysis or Vehicle Tracking Plan;

Provide design details of bin storage areas, utility boxes, cable runs and maintenance access points.

Support your design:

[National Design Guide \(2019\)](#)

[National Design Code Part 1: The Coding Process \(2021\)](#)

[National Design Code Part 2: Guidance Notes \(2021\)](#)

[Building for a Healthy Life \(2020\)](#)

[Manual for Streets 1 \(2007\)](#)

[South Oxfordshire and Vale of White Horse District Councils' wheeled bin policy and waste planning guidance \(2015\)](#)

[Waste management in buildings code of practice, BS5906 \(2005\)](#)

Design principles - Storage, services and utilities

Ensure the scheme:

4.18 looks at potential innovative collection systems for waste and recycling to help meet the targets of Joint Municipal Waste Management Strategy. This could include: reduction, reuse, recycling, diversion from landfill, and restricted volume of residual waste storage. Begin discussions with waste officers at the earliest possible opportunity so that the viability of the

4.19 scheme can be assessed early in the process;

4.20 Storage areas should be convenient for residents (integrated as part of the frontage or in a communal collection point if necessary), be visually screened from the public realm, unobtrusive and should avoid long access routes;

4.21 provides access between bin storage areas and collection vehicle access. Long and/or narrow paths/alleyways between rear gardens and the collection point should be avoided;

4.22 gives convenient access for service vehicles that avoids the need to frequently turn around, with priority to through routes;

4.23 integrates services such as substations, utility boxes, cable runs and maintenance access points positively into the scheme. These should not conflict with landscape features, drainage, tree planting (leaving enough room for trees to establish themselves) and/or the design of the public realm.

*Note: All design principles are applicable to all scales of development unless otherwise specified; *minor applications, **major applications*

Parking strategy and solutions

Goal: Integrate parking to support attractive streets and spaces

55. Providing sufficient car parking to meet the needs of residents whilst creating attractive and successful development schemes can be a significant challenge. Too much parking can visually dominate the street and weaken its enclosure (count garages and car ports towards parking spaces). Too little results in frustration for residents and visitors alike and can lead to indiscriminate parking. The need for parking is a reality however, and imaginative solutions should be adopted to respond to this challenge. Developments should be future proofed to ensure expensive retrofitting isn't required in the future (electric charging points).
56. Residents tend to favour parking solutions that maintain a line of sight between their dwelling and their vehicle. As such parking courts to the rear of properties tend to be less successful solutions.
57. Parking on-street remains one of the most successful ways to accommodate parking as part of a balanced solution. Parking on the street is an efficient use of space and people understand how it works. Unlike rear parking courts, on-street parking increases activity on the street and between the street and the house.
58. On-street parking should be designed into the street scene from the outset. It may be parallel to the kerb, angled to the kerb (echelon), perpendicular to the kerb or within a central reservation. However, it should not be allowed to dominate the environment or to negatively impact the character of a street. All solutions for parking within the street should benefit from landscaping and the materials used should be of the highest quality.
59. Developers should consider the promotion of public transport, car clubs, rural car clubs, bicycle and scooter hire schemes as a means of reducing the need for people to have their own vehicles. Consideration will need to be given to the parking requirements of hire or pool vehicles in accessible locations, as well as their storage and potential charging needs. Car free developments should also be considered in appropriate locations.

On plot parking

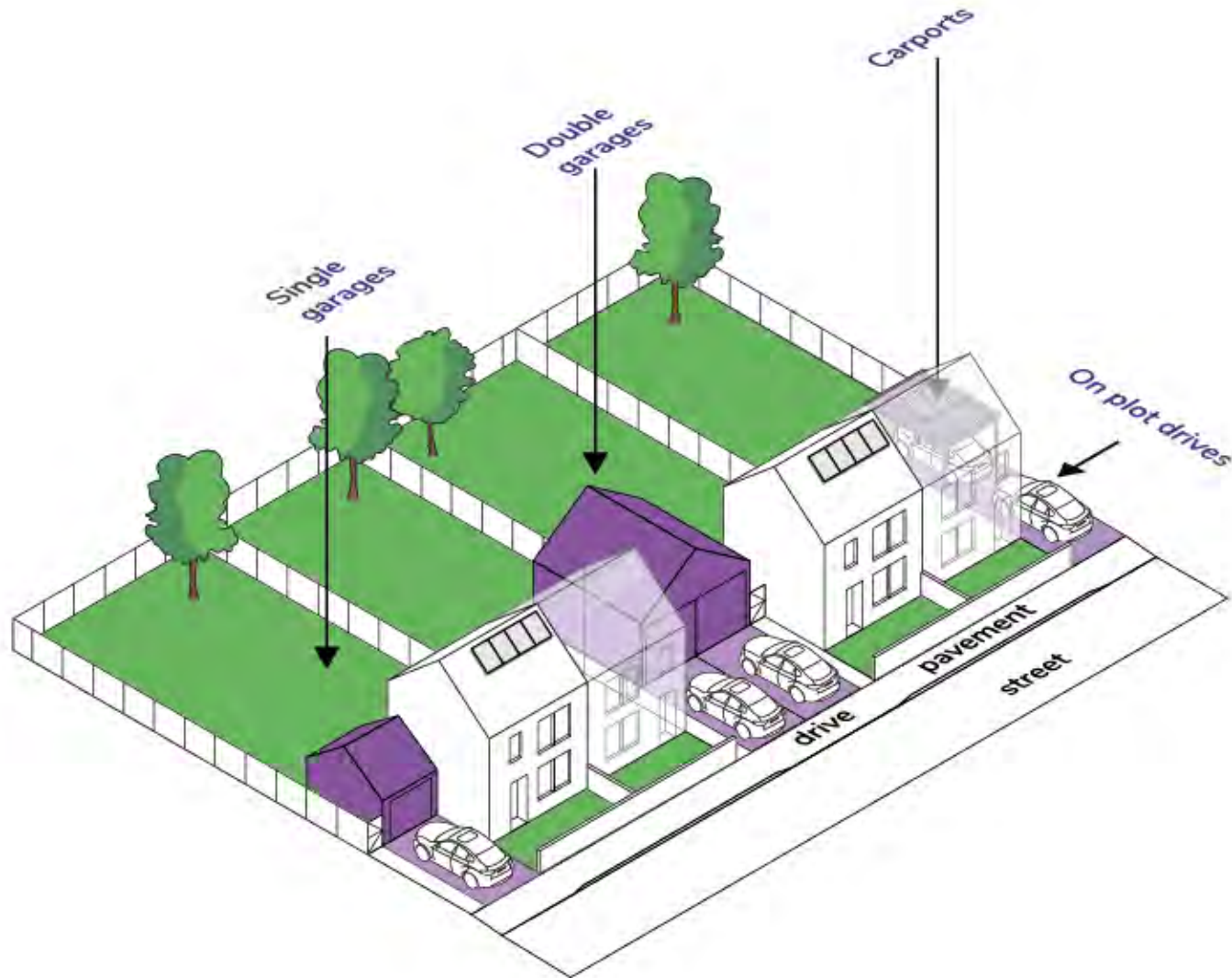


Figure 29: General on plot parking arrangements

Frontage parking

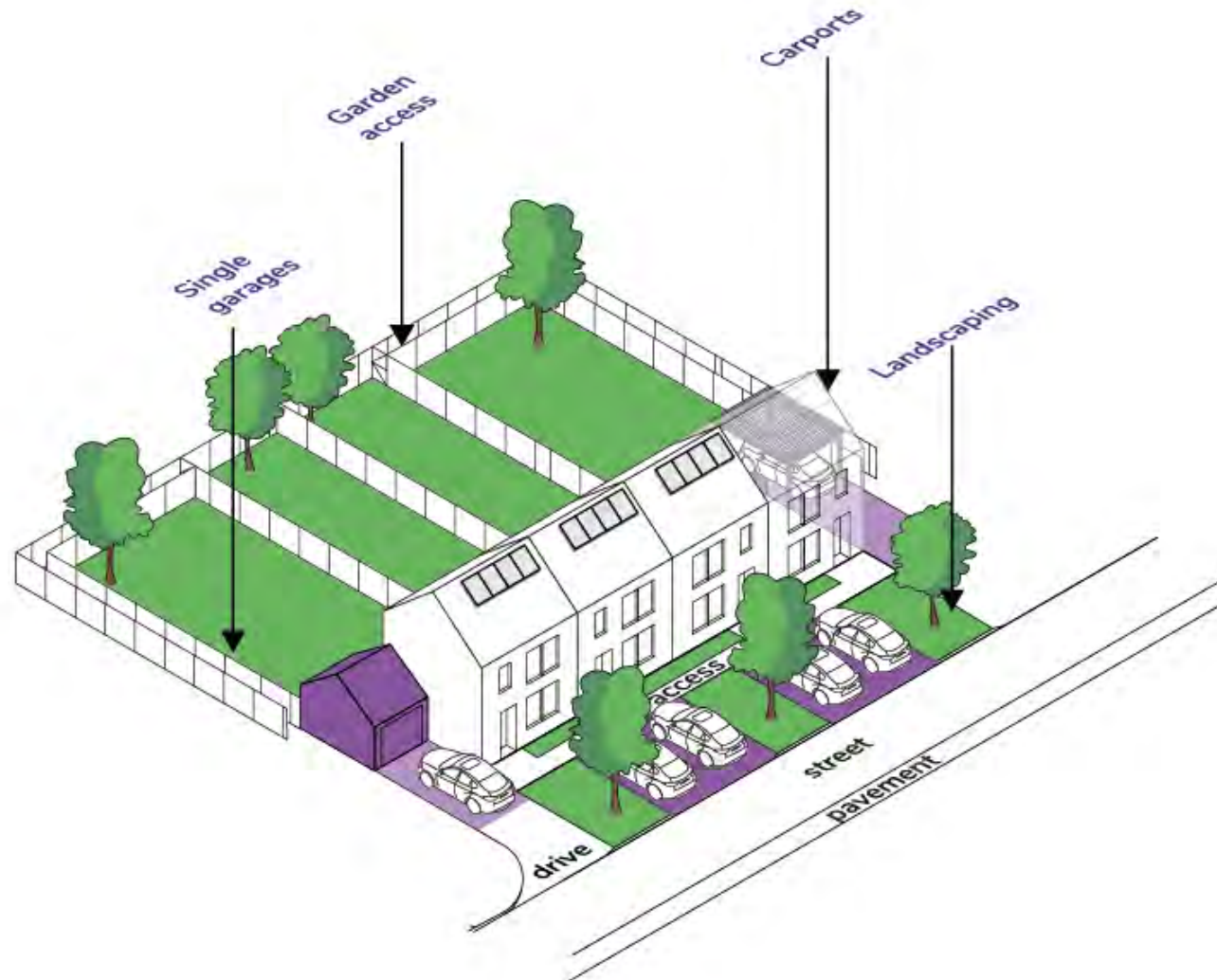


Figure 30: On plot parking arrangements

Parking courts

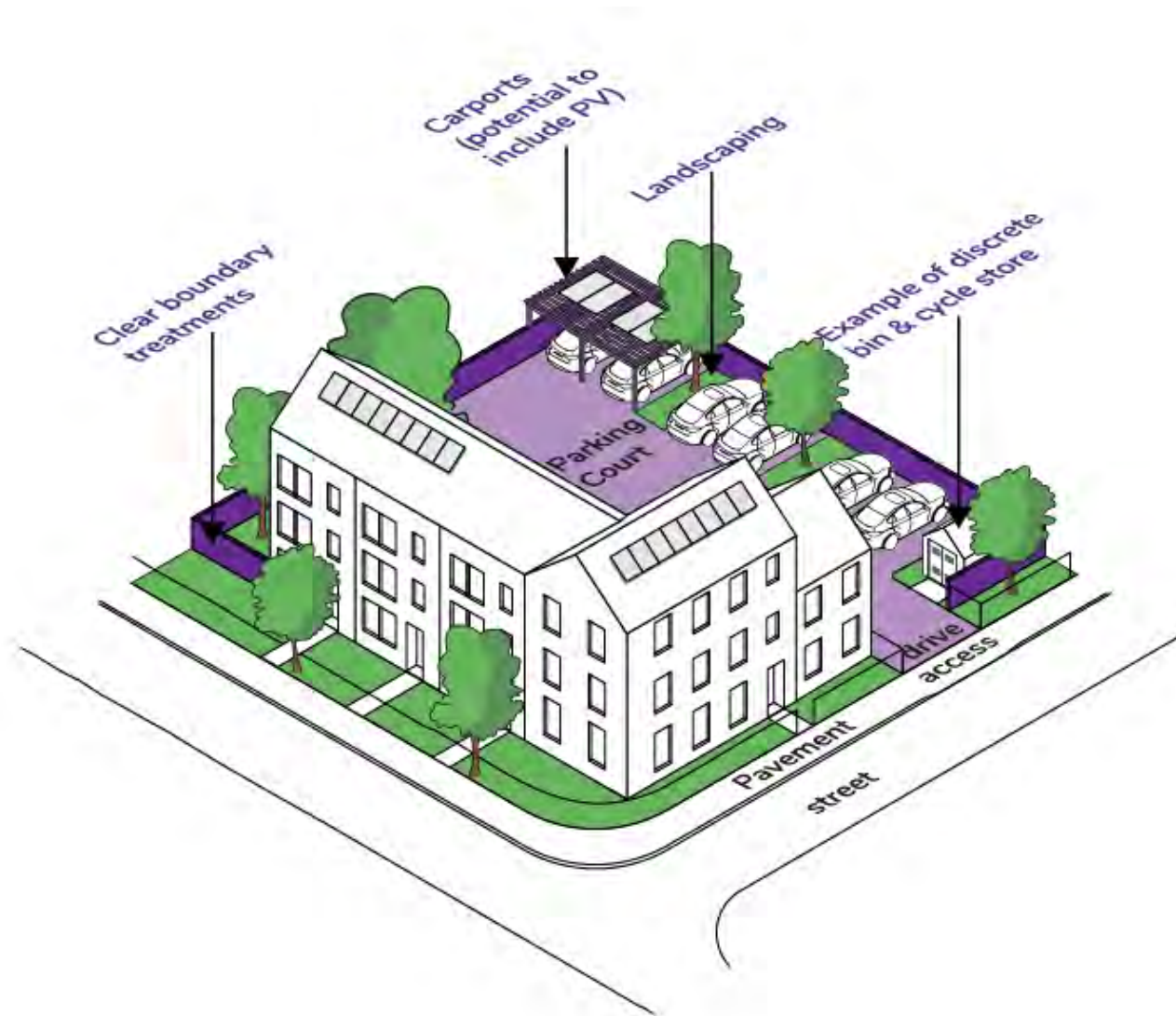


Figure 31: General parking court arrangements



On-plot parking (Tadpole Garden Village)



Example of an attractive rear courtyard with integrated planting and natural surveillance (Upton, Northamptonshire)



Electric charging point (North West Bicester, Oxfordshire)



On-street parking broken up by landscaping (Upton, Northampton)

Steps

Inform your design:

Prepare a plan demonstrating a variety of parking solutions including the needs of private plots, visitor and on-street parking and the ways to achieve them.

Communicate your design:

Prepare a parking strategy plan.

Support your design:

[Manual for Streets 1 \(DfT, 2007\)](#)

[Manual for Streets 2 \(ICHT, 2010\)](#)

[Oxfordshire Street Design Guide \(OCC, 2021\)](#)

[Oxfordshire County Council Parking Standards \(2012\)](#)

[Oxfordshire Transport and Access Group \(OXSTRAG\)](#)

[Streets for all \(Historic England, 2018\)](#)

[Electric Vehicle Charging in Residential and Non-Residential Buildings \(2019\)](#)

Design principles – Parking

Ensure the scheme:

- 4.23** has a range/variety of car parking solutions that relate to the order of street;
- 4.24** provides parking for both residents and visitors (including accessible parking bays) in accordance with Local Plan(s) and county level car parking standards;
- 4.25** keeps parking areas positioned to the front of properties (on-plot) to a maximum of eight spaces in a row, providing an adequate planting break every four adjacent spaces (equivalent to another parking space to allow for a tree, low-level planting, or access);
- 4.26** shows visitor parking spaces on street, where appropriate, and which can be easily recognised. Spaces should be located where they will be needed;
- 4.27** provides on-street parking designed as part of the street layout with a maximum of five bays separated by a kerb build out allowing adequate visibility for pedestrians crossing the road and space for tree planting or access;
- 4.28** avoids rear parking courts and these are only provided where all other options have been exhausted. They are small scale, well-landscaped and are overlooked by adjacent properties. They have been designed as part of the public realm and avoid single large expanses of tarmac;
- 4.29** uses small scale shared drives for parking, when located at the front of properties. These should be overlooked by active frontages from adjoining properties;
- 4.30** avoids tarmac and uses porous materials for side or front on-plot parking to distinguish ownership from the street scene;
- 4.31** avoids garages and car ports which can breaking up the enclosure and definition of the street. If provided, they should not be forward of the main building line, compromise the amount of private amenity space, or cause overshadowing issues. Large groups of garages and car ports should be avoided.

4.32 shows electric charging points have been provided (refer to climate mitigation and adaptation section for details). Until the emerging Oxfordshire County Council Parking Standards are adopted, we recommend one (on plot) EV charging point per dwelling. Where parking is provided communally (courtyards and flats) at least two EV points are recommended;

4.33 incorporates landscaping to enhance large areas of parking (carparks), and screens service areas to minimise their frontage onto public realm and/or streets without creating potential target areas for unsocial behaviour;

4.34 In more rural and lower density locations on-plot parking is an acceptable solution and should be landscaped and designed in such a manner that they do not dominate the front garden or streetscape;

4.35 provides creative solutions for attractive, convenient and safe (secure and overlooked) residential and on street cycle parking.

*Note: All design principles are applicable to all scales of development unless otherwise specified; *minor applications, **major applications*

Open space design

Goal: A range of open spaces, with clear purpose, that are accessible and can be used by all

60. All open space should be safe, attractive, and, where appropriate, publicly accessible. Open space should be of a size, location, and form appropriate for the intended use. Open spaces will avoid Space Left Over After Planning (SLOAP), narrow corridor spaces, and should not simply distribute open space to the periphery of the development. There is a fine line between small spaces that can contribute positively and large verges that do not serve a useful function. Landscape should not be used as a divisive measure between new and existing development.
61. New and existing landscapes and open spaces should be linked to form connected green networks, create areas for visual amenity, recreational use, and facilitate wildlife habitats. Where direct links are not possible, it may be appropriate to link these together through green routes, shared surface streets, and boulevards. Tree lined avenues can achieve a visual and physical connection to open space.
62. Open spaces need to offer choice for the needs and desires of all users. For example, they may provide outdoor gym equipment, edible gardens, vertical gardens, allotments, etc. By offering choice, you will address the needs of more people and may encourage healthier lifestyle choices. When creating the range of open spaces for the development, it is important to offer choice for all users.
63. Inclusive design will allow children, young people, and adults of all ages to interact with and enjoy their local open space together. The key to inclusive design of public open space is: safe, fully accessible pedestrian and cycle routes, even and stable paths with appropriate gradients, and places to rest.

General design considerations for open space

'Urban play': Play does not have to be swings and roundabouts. In this example, dancing water jets provide play opportunity within an urban context

Areas for adult play e.g. running loops and outdoor gyms

Open spaces are well overlooked by neighbouring properties

informal open space

Network of informal seating spaces focused within green corridor infrastructure



Places to meet, greet and relax: in this case outdoor seating for adjoining cafe

Parking provision at attractor location

Integrated footpath/cycle links create opportunities for informal recreation

Network of informal play spaces focused within green corridor infrastructure

Natural play e.g. 'beach' for pond dipping

Figure 32: Design considerations for formal open space and focal points



Example of informal recreation (Abbey meadow, Abingdon)



Example of well-integrated formal play benefiting from natural surveillance (Sutton Courtenay)



Example of well-integrated formal play (John Leigh, Manchester)



Incidental play (Buscot Park, Faringdon)

Steps

Inform your design:

Use the development opportunities and constraints plan to identify what types of open spaces are in the local area. Choose open spaces that will complement and/or add to the range of uses;

Refer to the councils' open space standards to identify the technical requirements and dimensions of types of open space;

Refer to the Developers Contributions Supplementary Planning Documents which sets out the open space requirements for new developments, in terms of quantity, quality, and accessibility

Communicate your design:

Prepare a Landscape Strategy showing the location and identifying the purpose of the open space. Include the type of furniture and equipment to be provided in the space, and how the open spaces coordinate with other design requirements of the site, such as biodiversity and drainage;

Illustrate how the open spaces work together with existing open spaces in the local area. Explain how they provide a range of different spaces;

Provide a landscape management plan to illustrate how the site will be maintained, both during establishment and longer term.

Support your design:

[Building for a Healthy Life \(2020\)](#)

[Healthy weight environments: using the planning system Active by Design \(2014\)](#)

[Active Design, planning for health and wellbeing through sport and physical activity \(2015\)](#)

[South Oxfordshire District Councils' Developer Contribution SPDs \(2021\)](#)

[Vale of White Horse District Councils' Developer Contribution SPDs \(2021\)](#)

[Sport England's Active Design Guidance](#)

[A good practice guide to disabled people's access in the countryside \(2005\)](#)

[National Disability Strategy \(2021\)](#)

Design principles - Open space

Ensure space(s):

- 4.36** are not pushed to the periphery of the development and are properly integrated with the rest of the development;
- 4.37** have a clear purpose; they are 'usable', are of the right size, shape, and layout;
- 4.38** meet the needs of all users, are safe, attractive, and accessible;
- 4.39** include open space that is accessible for all users, including people with disabilities, parents / carers, pregnant women, teenagers, children, and older people;
- 4.40** offer a choice for the needs and desires of all users (for example; a waiting space next to a school, space to fly a kite or kick a football, an outdoor gym, socialising areas, or seating close to entrances for those less mobile);
- 4.41** recognise the need to preserve quiet open spaces;
- 4.42** use the natural features identified in the opportunities and constraints plan as focal points;
- 4.43** are integrated as part of the natural landscape features of the scheme and located so that residents can access them easily and directly; this will provide instant 'maturity' as well as creating windbreaks, visual screening, and shelter
- 4.44** are linked with existing spaces to form connected green networks along key walking and cycling routes;
- 4.45** are located within walking distance (easily accessible) of new and existing development
- 4.46** are appropriately defined and bounded by buildings with windows providing natural surveillance;
- 4.47** are not dominated with parking, especially at the ends of street and pedestrian/ cycle corridors;
- 4.48** include opportunities to encourage local food growing such as: community orchards, provision of allotments, and other community garden projects;
- 4.49** provide opportunities to have access to community gardens or enough space to grow food (e.g. a roof, allotments, communal gardens or a balcony);

4.50 provides opportunities for people to engage with a place through their senses (sensory richness);

4.51 are delivered in an early phase.**

Note: All design principles are applicable to all scales of development unless otherwise specified; *minor applications, **major applications

Play space and youth provision

Goal: Provide a diverse range of safe and inclusive play areas and youth provision that meets the needs of the community

64. The location of play spaces and youth provision needs to consider the surrounding context. Factors to consider will be: the intended age of the children and youth using the space, the size, the type of equipment, and the proximity to existing residential properties and other play provision. Play spaces should be accessible to all children and teenagers. Integrate natural and nature-based play, where possible and make sure that play areas feature adequate shade, planting, and seating with both active and social play. Play and youth facilities should be delivered and opened in a timely manner.
65. Inclusive play spaces are places where a wide range of users can play in a variety of ways and learn from each other. Through careful design and choice of equipment, play spaces can be accessible to all children, while offering varying degrees of challenge. Play spaces should provide for both active, social, and sensory play along with areas to relax, to accommodate the needs of all children. Play industry publication Plan inclusive Play Areas (PiPA) offers a useful checklist of items for designers to consider when designing play spaces. All equipped play spaces should provide some fully inclusive moving items such as: level access roundabouts, seesaws, or trampolines.

Play space and youth provision

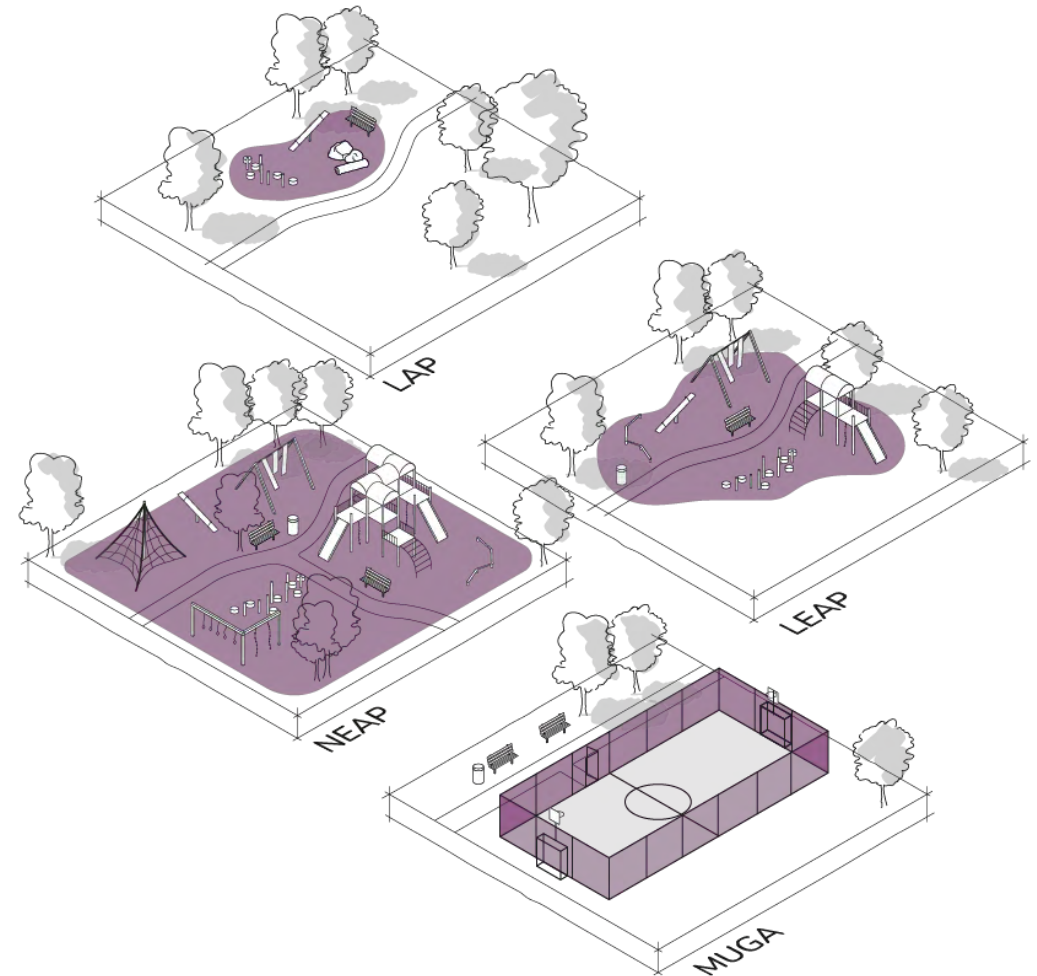


Figure 33: The different types of play spaces and youth provision

Local Areas of Play (LAP)

66. A small area of open space specifically designated, and primarily laid out, for young children up to 6 years old to play close to where they live i.e. within one minute's walking time. LAPs are designed to allow for ease of observation and supervision and primarily function to encourage informal play and social interaction for toddlers. The LAP requires no play equipment, as such, relies more on demonstrative features that indicate play is positively encouraged

Local Equipped Areas of Play (LEAP)

67. An area of open space specifically designed and laid out with features, including equipment, for children who are beginning to play independently, predominantly 0 to 8 years. The nature of equipment and structures should reflect the number of children being catered for, though provision for a minimum number of six play experiences is recommended.

68. Play features, including equipment, are an integral part of the LEAP and the attractiveness of such spaces. It is also important that the space can be used for physical activity and games. LEAPs should also include landscaped areas of play to compliment formal play equipment. Landscapes should be imaginatively designed and contoured using natural materials, as far as is possible, such as logs or boulders which create an attractive setting for play.

Neighbourhood Equipped Area of Play (NEAP)

69. This is an area of open space specifically designated, laid out, and equipped for older children (8 to 11 years and older), but potentially with play opportunities for younger children as well. NEAP areas can provide play equipment and a hard surface area for ball games, or wheeled activities, such as roller skating or cycling. NEAPs may provide other facilities such as a ramp for skateboarding, a rebound wall, and a shelter for meeting and socialising. NEAPs can often be co-located with LEAP provision to cover children aged 0 to 11 years old plus older children and young people aged 12 years and over.

Youth Space and Multi Use Games Area (MUGA)

70. Older children and young people aged 12 to 18 years often enjoy traditional play activities, such as climbing and swinging, as well as facilities for socialising, performance, fitness, ball games, and wheel sports (UN Convention on the Rights of the Child includes everyone under the age of 18 have the right to play).

71. Traditionally, youth provision has been focused on a range of active sports such as: skate parks, BMX tracks, and MUGAs. However youth space needs to be designed to appeal to a much wider range of teenagers, of both sexes, and not be easily dominated by one type of user. Elements that could be included in a youth space are wide ranging, such as: swings, hammocks, high bars, outdoor gyms, bouldering structures,

more open (less cage like), and divided areas of MUGAs. A combination of these can ensure one user group cannot dominate, and will encourage a wider range of users. Youth spaces should consider performance spaces, social seating, shelter, elevated areas, and interactive sport and play equipment.

72. Youth provision should be an integral part of public open space design. Youth provision should be easily and safely accessed in the evenings. Spaces should be semi-private but be overlooked for ease of informal observation and supervision.



Play area set within existing landscaping (Sutton Courtenay)



Play area well overlooked (Sutton Courtenay)



Bespoke play space to reflect countryside edge setting (Kennington)



MUGA (Southern Town Park in Abingdon)

Steps

Inform your design:

Use Local Plan Policy and Developers Contributions SPD to determine the amount of play and youth provision required for the development. This will be supported by the opportunities and constraints plan to identify and take into account the accessibility and type of other provision within the locality.

Communicate your design:

Prepare a Play and Youth Provision Strategy to indicate how facilities are to be provided within the development and how they provide accessible play. The strategy should set out how play areas integrate with the wider areas of open space and how they complement provision both on and off site;

Mark the areas for play and youth provisions, and their associated buffer zones, on the site layout plans;

Prepare detailed plans showing the play and youth provision, including details of safer surfacing, planting, paths, seating, bins, equipment, and the intended age range and accessibility of equipment.

Support your design:

[Vale of White Horse, Developer Contributions SPD: Delivering infrastructure to support development \(2021\)](#)

[South Oxfordshire, Developer Contributions SPD: Draft for public consultation \(2022\)](#)

[Fields in Trust: Beyond the Six Acre Standard \(2020\) Design for Play: A guide to creating successful play spaces \(2008\)](#)

[Public Space Lessons: Designing and planning for play \(2008\) National Disability Strategy \(2021\)](#)

Design principles - play space and youth provision design

Ensure the scheme:

- 4.52** refers to the current councils Open Space Policy and Developers contributions Supplementary Planning Document and Local Plan policies, which set out the open space requirements for new developments, in terms of quantity, quality, and accessibility;
- 4.53** is appropriate to the community needs and unique to the development;
- 4.54** includes both formal and informal, active and social play, and youth spaces that offer stimulating and challenging environments that can be accessed by all children, whatever their needs;
- 4.55** locates play spaces and youth provision that is integrated with local open spaces and has a clear access routes for all users, rather than an isolated/separate features;
- 4.56** is located so that play spaces and youth provision do not cause disturbance to the occupants of nearby buildings but has good natural surveillance.
- 4.57** provides at least the minimum space requirement for play spaces and provides suitable buffer zones. Play spaces need to be designed to allow for adaption and expansion in the future;
- 4.58** provides opportunities for: play, social interaction, senses stimulation, quiet space, and enables young people to claim the space as their own
- 4.59** considers the size of its facilities with respect to the intended age of the children using them;
- 4.60** uses best practice guidance on inclusive play to ensure play spaces are accessible to all children;
- 4.61** encourages natural elements and features within play spaces, including planting, to provide a range of textures, scents, colours, and shade;
- 4.62** provides spaces for older children to socialise and be active, in appropriate locations where they can feel safe while not being intimidating to other people;

4.63 provides youth provision that is complimentary to local facilities, including a mixture of facilities, such as: open access MUGAs, BMX/skateboard parks, and pump tracks, as well as more challenging or social play equipment for older children, such as: structures for parkour, climbing/ bouldering walls, seating clusters, and electronic play;

4.64 provides opportunities for incorporating incidental play features in both green open spaces and more urban open spaces.

*Note: All design principles are applicable to all scales of development unless otherwise specified; *minor applications, **major applications*

Public art

Goal: Incorporate public art into new and existing developments to enhance the visual quality and create a sense of identity.

73. Public art needs to be taken into consideration at the outset of the design process, be of local relevance/significance to ensure it makes a valuable contribution to the character and success of a development. Public art is art for the public specifically designed by artists for the purpose of public display (i.e. it is beyond the artist's work merely shown in public spaces).

Public art is always site-specific and can take many forms that may include sculptures, fencing, paving, (this is covered under street furniture), street furniture, mosaics, glass work, flooring, lighting gateways or even community events.

74. Public art provides a great mechanism for leisure and planning to meet the broader Council's corporate objectives. Public art features can be accepted as part of a planning application or worked as a project within the design and build of a scheme, sometimes secured via Section 106 or through Community Infrastructure Contributions (CIL), or incorporated within a planning application.

Public art



Figure 34: Integrate art into the built environment (The Fairmile, Cholsey)



Public space, willow sphere (Cholsey meadows)



Brick relief, district centre wall (Didcot)



Public sculpture, the swirl (Didcot)



Public seating in open space, benches (Chinnor)

Steps

Inform your design:

Public engagement
Design competitions

Communicate your design:

Show the evolution of your design from initial concept to final design

Support your design:

[Design Council Artists and Places \(2008\)](#)

[Association for Public Art](#)

[Public Art online](#)

Design principles - Public art

Ensure the scheme, or public art in any new development:

4.65 is appropriately located and integrated. Relates to the design rationale of the development and helps create a place or feature (depending on the scale of development). This should be considered early in the design process.

4.66 is of the highest quality;

4.67 is designed and created by professional artists;

4.68 has local relevance/significance (if not to the site then to the local area);

4.69 is informed by public participation and involvement where appropriate;

4.70 is informed by liaison and development with the Arts Development Officer.

*Note: All design principles are applicable to all scales of development unless otherwise specified; *minor applications, **major applications*

General principles

Goal: Respect the local context whilst striving for excellence in architectural quality and sustainability.

75. South and Vale have a beautiful landscape character and a mix of towns and villages with locally distinctive buildings. However, many recent developments do not reflect that local distinctiveness and they could be anywhere in the UK. New development must create a positive character, with an identity that relates to the specific characteristics of the district.

76. The building forms used along a street should create rhythm and interest. Subtle variations in the height and width of buildings can add visual interest to the street, making it more attractive and interesting.

77. The scale of new development should be appropriate and sensitive to its context. Heights of buildings should be informed by contextual analysis. A variety of building heights along street frontages can also help to achieve this.

78. The form and massing of development can make a significant contribution to the character of a neighbourhood. The majority of traditional buildings in South and Vale, in both urban and rural areas, adopt a very consistent, simple form, with rectangular floor plans and pitched roofs. New development should adopt a simple form - but good contemporary design that respects context will be welcomed. Note that articulation of massing and roof line can help to present variety along the building frontage.

79. Note that in order to design a building to be as energy efficient (as close to zero-carbon) as possible this may result in conflict with other design principles in this Design Guide. When this occurs, be prepared to explain why this happens and explain why your solution is better.



Figure 35: Establishing built form, character and identity (major example)



Figure 35a: Establishing built form, character and identity (minor example)

Town centre

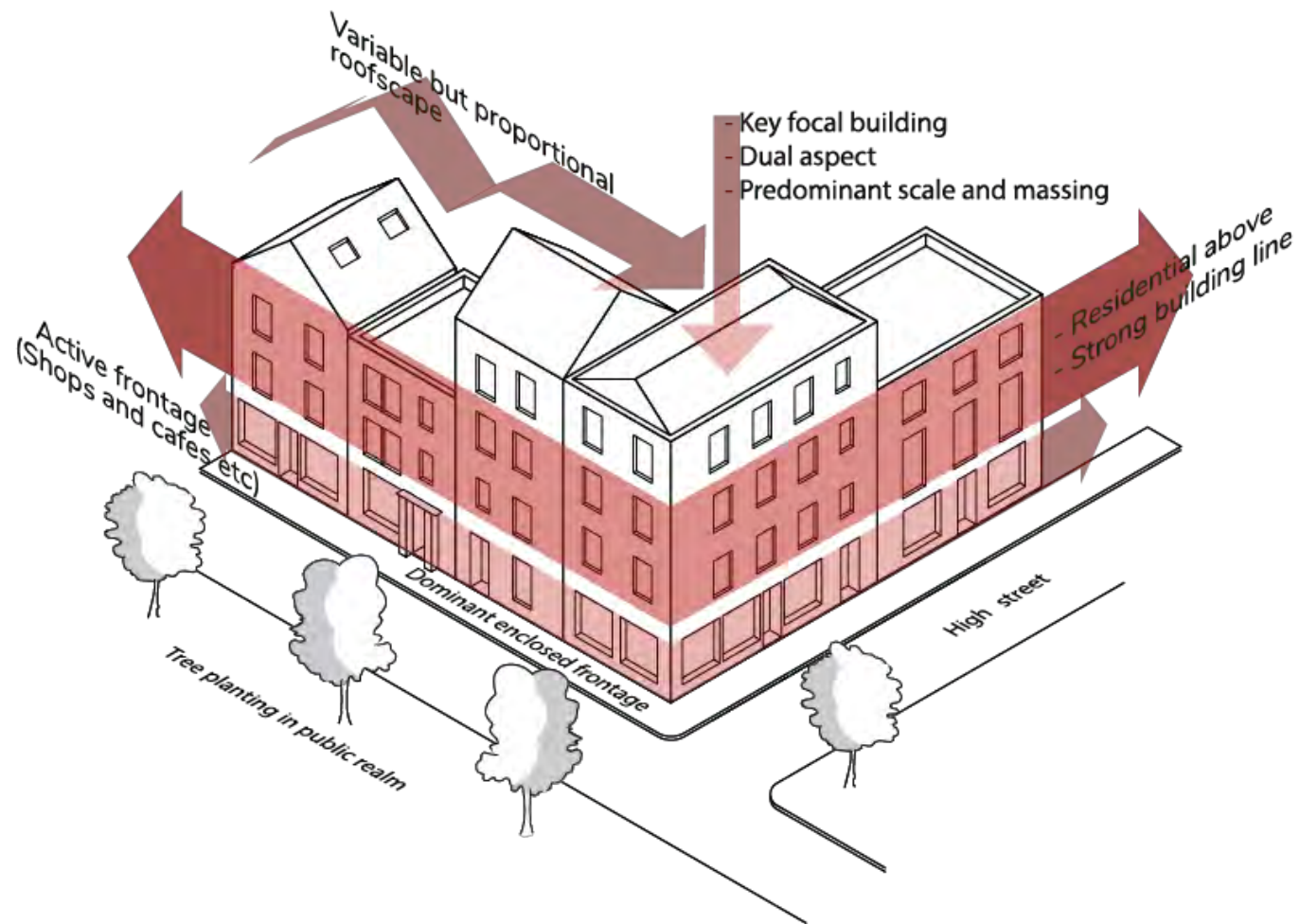


Figure 36: General character and built form of town centres

Urban built form



Figure 37: General character and built form of urban areas

Suburban

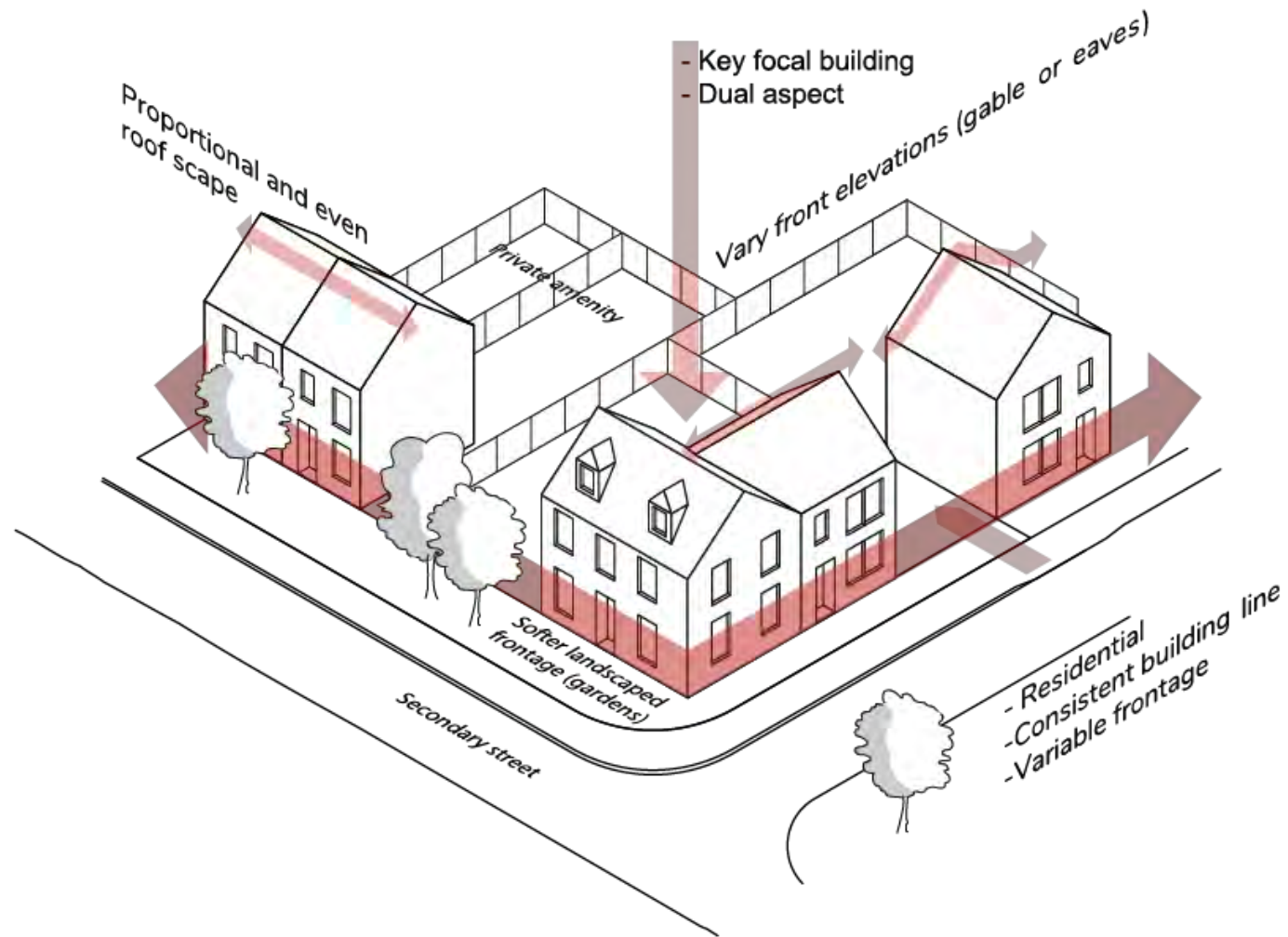


Figure 38: General character and built form of suburban areas

Lower density



Figure 39: General character and built form of lower density areas



Examples of how corner situations can be resolved with two-fronted properties, providing surveillance and active frontages in both directions (Great Western Park, Didcot)



Defining scale at key locations



An example of how local materials can be used in a contemporary way (Goring-on-Thames)



Defining enclosure (Upton, Northamptonshire)

Steps

Inform your design:

A robust character assessment of the form and design of the buildings in the local area should be undertaken. This should focus on buildings of high-quality design in the wider context of the site and not solely on the nearest buildings to the site.

Communicate your design:

Demonstrate how the form of the buildings and their design relate to existing buildings in the local area by showing what cues have been translated into the design;

Indicate how corner plots and focal points have been addressed.

Support your design:

[National Design Guide \(2019\)](#)

[National Design Code Part 1: The Coding Process \(2021\)](#)

[National Design Code Part 2: Guidance Notes \(2021\)](#)

[Building for a Healthy Life \(2020\)](#)

Design principles - General built form

Ensure the scheme:

- 5.1 complements/responds positively to the character and local vernacular (architectural style) identified as part of the character assessment of the area. This includes wider character such as streets rhythm, walls, railing, gardens, trees, etc.;
- 5.2 is sensitive to its context regarding scale, massing and height. In most instances new development should adopt a simple form. An uplift in scale, massing or height may be appropriate for landmark buildings in a key location, or more complex forms, when responding to a specific character area;
- 5.3 works with and responds positively to the existing landscape, topography and settlement pattern, including recognising glimpsed views in and out the development and important views across the site;
- 5.4 breaks down larger footprint buildings to comprise a number of simple, geometric forms to reduce their apparent bulk. Floor plans that necessitate flat roof sections should be avoided;
- 5.5 maintains established building lines and predominant plot patterns;

- 5.6** has a landmark or feature building with high quality materials and good use of detailing to stand out when in prominent locations, such as gateways, key vistas, and corner plots;
- 5.7** avoids long, blank (windowless or without material detail) elevations when visible from an adjacent street / public realm, parking area or public space;
- 5.8** provides dual aspect, such as on corner plots, return materials details, fenestration and landscaping to maintain a consistent façade. Blank elevations or gable ends will not be acceptable;
- 5.9** has entrances to buildings (including houses, ground floor or communal entrances for flats and non-residential uses) which directly face onto the street and are clearly visible and identifiable from the public realm;
- 5.10** has a built form designed to ensure good and direct natural passive surveillance over streets, public spaces and parking to design out and prevent crime;
- 5.11** has articulated ground floors of buildings with windows and doors and interesting detail (through the use of materials, datum line or façade detail) to create a development with a more human scale;
- 5.12** uses materials that are sustainable and have been informed by the character and appearance of the surrounding area;
- 5.13** has balconies (where provided) that are able to accommodate a table and chairs and space for planting/kitchen gardening;
- 5.14** mitigates the impact of signage (by using an appropriate scale) onto the public realm;
- 5.15** incorporates green and/or brown roofs/roof gardens on flat roof buildings and vertical gardens. Building design should seek to integrate biodiversity enhancements wherever possible. These could be through the provision of green walls/roofs, or faunal features (bird/bat boxes). They can be discretely incorporated into structures, or made into focal points, and will contribute to the need for development to deliver biodiversity net gain.

*Note: All design principles are applicable to all scales of development unless otherwise specified; *minor applications, **major applications*

Apartments

Goal: To make sure that apartments respond in a contextual and sensitive way to their setting.

80. Apartments, also known as flats, are sustainable forms of development because they increase housing density and therefore reduce the pressure for development on greenfield land. They also provide a wider choice of dwelling size and type, meeting the needs of more residents. Designing apartments can also be a challenge to achieve a visually interesting and functional building that respects the character and appearance of the local area. Their scale, height and massing, along with the requirements for parking, bin storage and private amenity space, means that clear guidance on well-established design principles is required to ensure that the proposed buildings can be as successful as possible.

Apartments

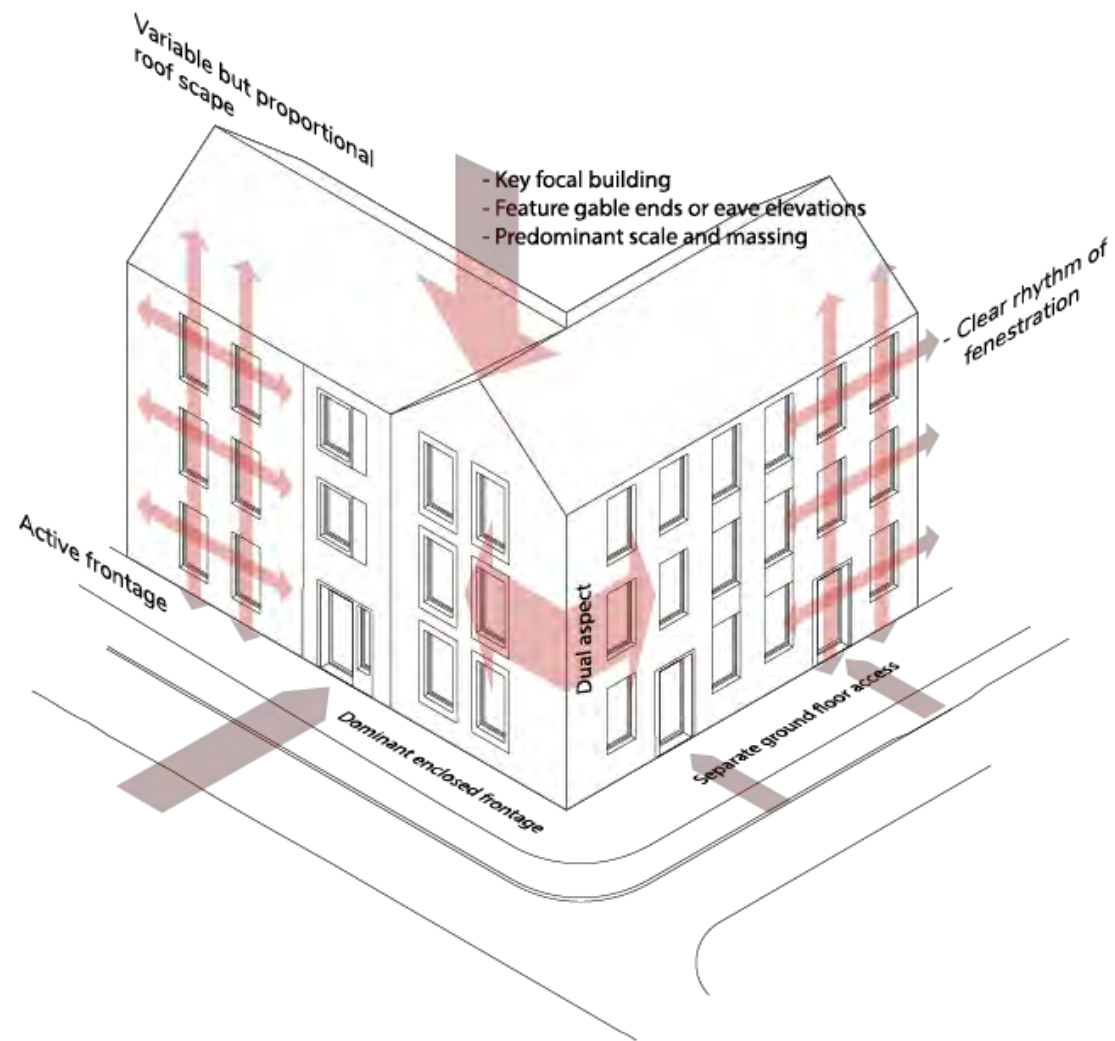
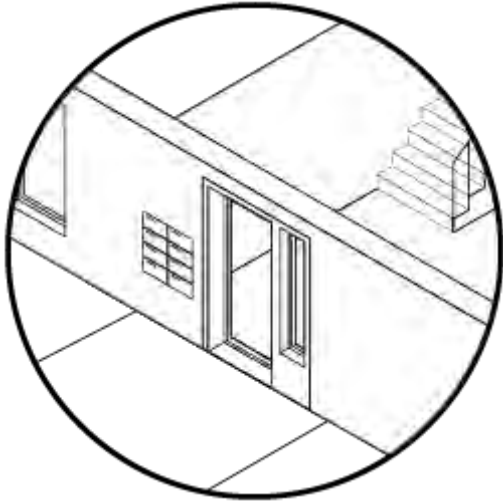
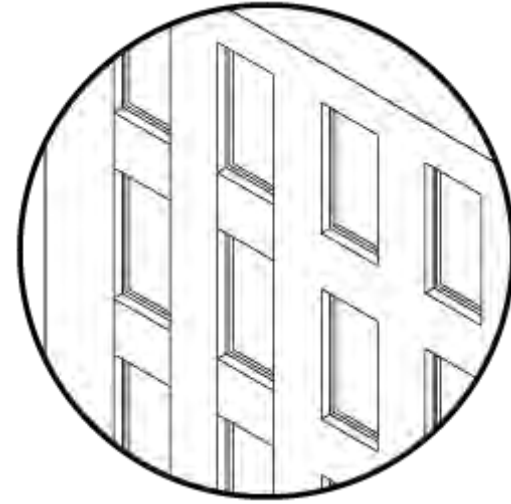


Figure 40: Consider the key features and composition of an apartment building

Key features



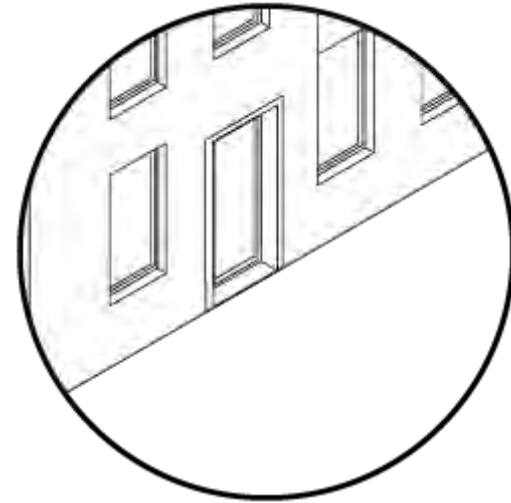
Secure and prominent main entrances



Ensure a rhythm of fenestration



Make features of gable / prominent elevations



Separate entrances to ground floor apartments

Figure 41: Apartments, key features



Newbuilt apartments with visual interest and overlooking open space (Accordia, Cambridge)



Newbuilt apartments with good natural surveillance, Mariners Quay (Newport, Wales)



Apartments in a converted building (Henley)



Newbuilt apartments that turn the corner (Winchester, Hampshire)

Design principles – Apartments

Ensure the scheme:

- 5.15** respects their surrounding context in terms of scale and height. In some instances, taller buildings could be used as an opportunity to create landmark buildings;
- 5.16** is broken down into a series of components to reduce their perceived bulk and massing where large footprint buildings are needed;
- 5.17** locates main entrances directly facing onto the street and clearly visible from the public realm. All building entrances should be welcoming and easily identifiable by all users to help improve legibility;
- 5.18** provides individual entrances for ground floor dwellings where they front the public realm and provide generous sized entrances, well-lit by natural light and naturally ventilated;
- 5.19** has access to outdoor amenity space. This can be provided in the form of private gardens for ground floor flats, balconies, roof gardens or terraces, or private shared gardens;

- 5.20** keeps the number of dwellings accessed from a single core to a minimum;
- 5.21** includes accessible parking bays and visitor parking that is well overlooked and integrated into the landscaping strategy for the site. Parking must not visually dominate the setting of the buildings;
- 5.22** has attractive dedicated visitor cycle parking provided close to main entrances and well overlooked by habitable rooms;
- 5.23** has secure and convenient cycle storage and separate refuse areas provided within the main buildings preferably close to main entrances.

*Note: All design principles are applicable to all scales of development unless otherwise specified; *minor applications, **major applications*

Householder extensions and outbuildings

Goal: To achieve extensions to dwellings that respond to the needs of the occupants in a way that is sensitive to the character and appearance of the original dwelling and street scene.

81. Extensions to dwellings can have a significant impact on the character and appearance of a dwelling itself and the street or area in which it is set in. A well-designed extension can enhance the appearance and value of a property, whereas an unsympathetic extension can have a harmful impact, create problems for neighbouring residents, and affect the overall character of the area. To establish the effect a proposed building will have on existing properties with regards to obstructing daylight to existing windows/rooms, check the 25 and 45 degree rule.
82. Extensions present an opportunity to improve insulation and heating systems in a property or incorporate water saving devices. This can increase the sustainability of a home and lower its carbon footprint whilst reducing the cost of heating a home. Consider carefully how your proposed extension could improve the thermal efficiency of your property. Some smaller-scale extensions may constitute 'permitted development' which means they do not need planning permission.
To understand if your extension may be permitted development see:
[Planning Portal - Permitted development](#)
83. If planning permission is not required, we would still strongly encourage you to follow the best practice guidance in this document to ensure that the design of your extension can be the best that it can be.
To make your home or extension more sustainable see:
[Climate and sustainability - Sustainable Development](#)
84. If a building has been identified as being Statutorily Listed or is located within a Conservation Area or AONB, some forms of development or alteration that would otherwise be classed as permitted development will require planning permission, Listed Building consent or combinations of these.
85. A Design and Access Statement may need to be submitted for applications for Listed Building consent and for planning applications in Conservation Areas.
86. Extensions to historic buildings can be harmful if their significance is not fully understood.
87. The Council can provide further assistance and guidance about what does and does not require planning permission and advice about the design of the proposal. If planning permission is required, the Council has a validation checklist for householders to help people in preparing applications

and ensure all necessary information is included, for more information see:

[South Oxfordshire validation checklist](#)

[Vale of White Horse validation checklist](#)

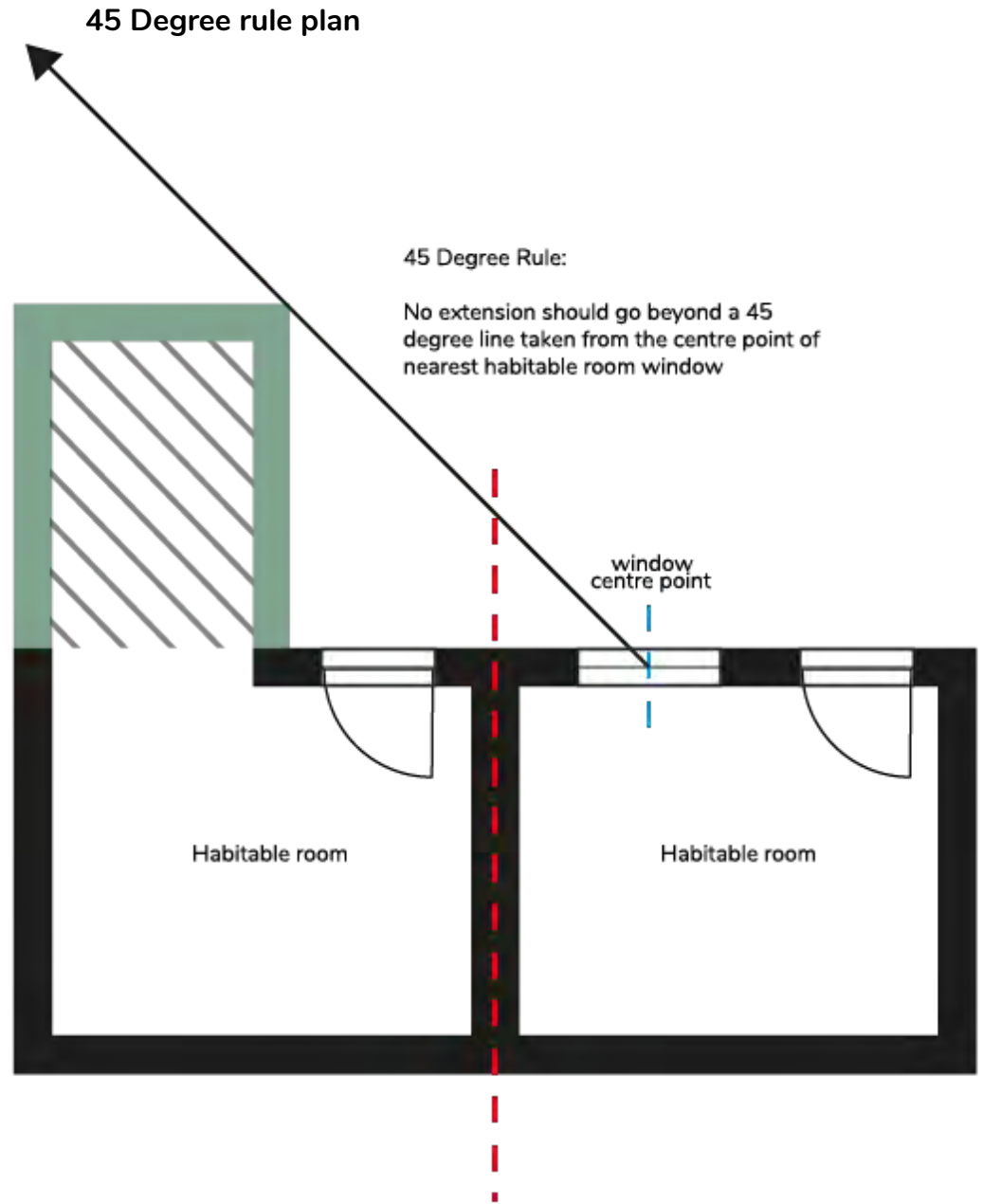


Figure 41: Use the 45-degree rule to avoid impact on neighbouring development

45 Degree rule elevation

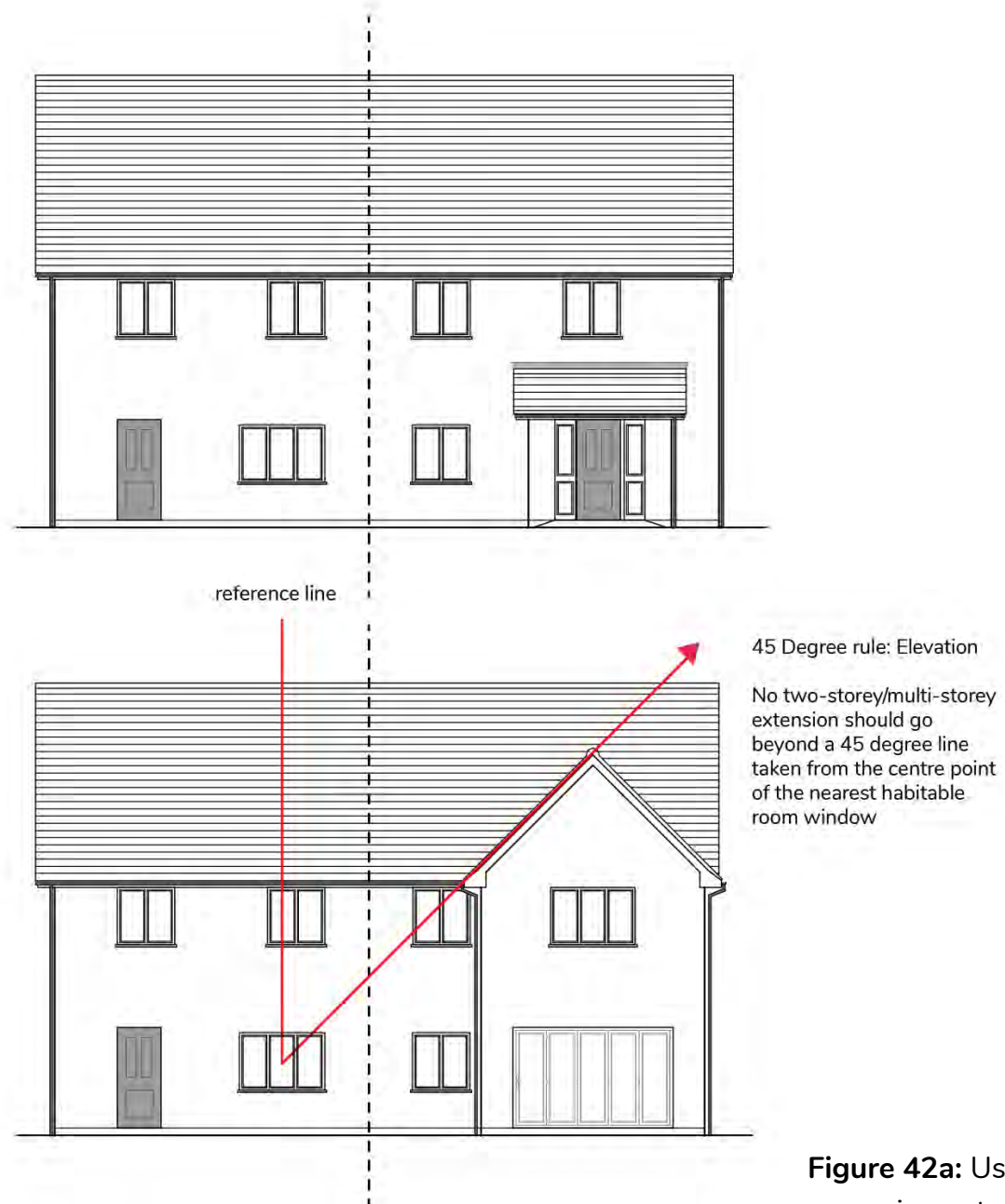


Figure 42a: Use the 45-degree rule to avoid impact on neighbouring development

25 Degree rule

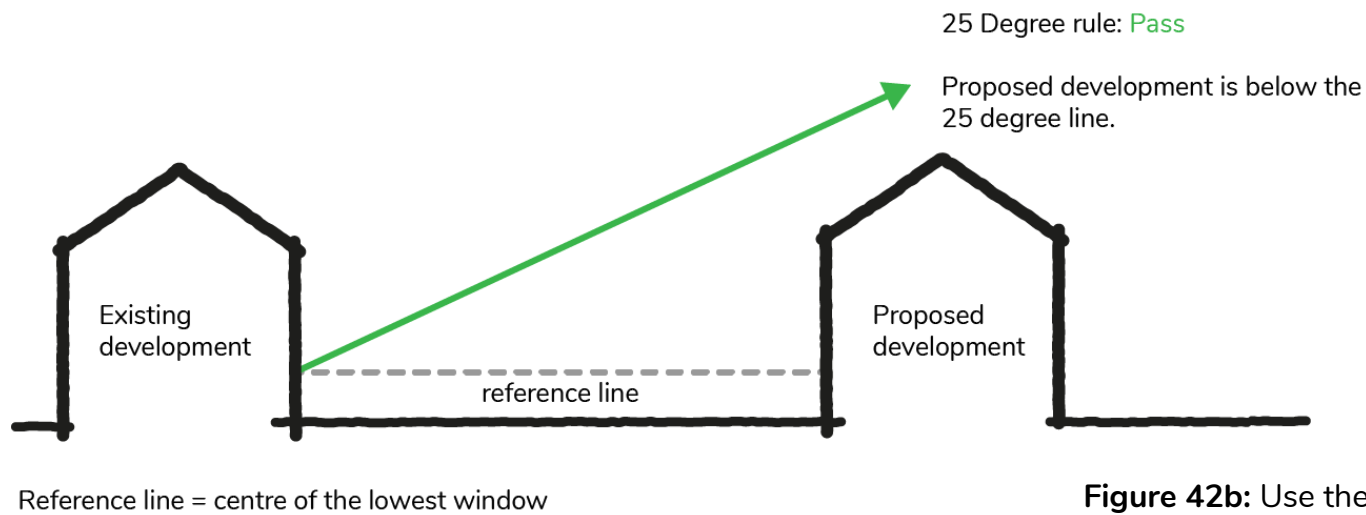
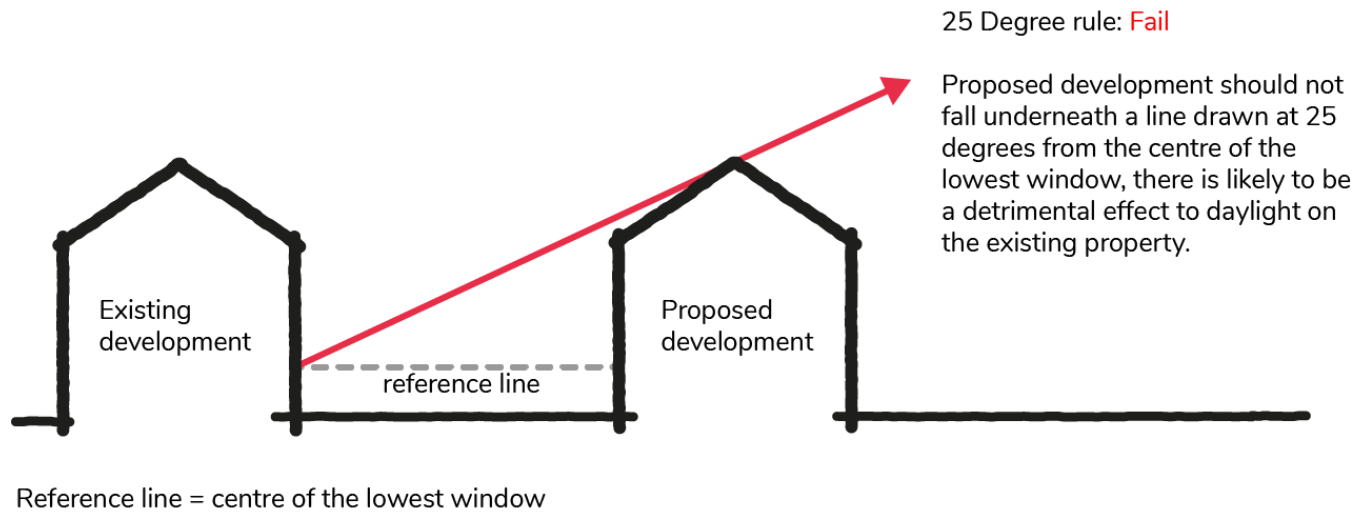


Figure 42b: Use the 25-degree rule to avoid impact on neighbouring development



Extension in keeping with the existing character and appearance of the house (Kingston Blount)



Successful contemporary extensions to a traditional building in Watlington



Successful two-storey extension subordinate to the principle dwelling



Another example of an extension in keeping with character and appearance of the original dwelling

Steps

Inform your design:

Technical studies including tree surveys where appropriate.

Identify if your property is:

a statutorily listed building, or is located on land within:

a conservation area,

an AONB (Area of Outstanding Natural Beauty),

[South and Vale public GIS website](#)

Calculate the volume of the development. Certain development volumes will fall under permitted development, you can find out more information on what are permitted development volume limits here:

[Planning Portal](#)

The Council's Planning Service can advise on whether planning permission is required through the permitted development enquiry form. [South](#) or [Vale](#)

Communicate your design:

Provide a site plan clearly identifying the existing building and the proposed extension;

Provide clear, elevations, all applicable floor plans and a roof plan;

Three dimensional models where applicable.

Support your design:

[The Planning portal: Do you need permission?](#)

[The Planning portal: Interactive house guide](#) [The](#)

[Planning portal: common projects](#)

Pre-application advice service: [South & Vale](#) Validation

checklist: [South & Vale](#)

Design principles - Householder extensions

Ensure the scheme:

- 5.24 responds to and respect the character and appearance of the area and street scene;
- 5.25 maintains established building lines and predominant plot patterns;
- 5.26 uses simple, uncomplicated building forms that complement and coordinate with the scale, form and massing of the original dwelling;
- 5.27 uses building materials matching those of the existing dwelling (or justification has been provided explaining the appropriateness of the alternatives proposed);
- 5.28 ensures the original building remains the visually dominant element of the property (whether it is an extension, a self-contained annex, an outbuilding or a garage);
- 5.29 has a roof form appropriate to the original dwelling, generally this should be constructed with the same angle of pitch as the existing roof. Overly complicated roof profiles to be avoided;

5.30 ensures any existing external access from the front to the rear garden has been retained where possible;

5.31 responds to the existing rhythm of windows, door and openings. Note that the position, size, proportion, height and style of new windows and doors and the ratio of solid wall to openings all help to define the character of a dwelling;

5.32 demonstrates that it will not result in the significant loss of light (as determined by BRE calculations where deemed necessary).

Neighbouring amenity:

5.33 Developers and applicants should be mindful of the impact of their proposals on the amenity of future and existing adjacent occupiers. Proposals should not give rise to any unacceptable harm.

Extensions and alterations must:

5.34 have been informed by the positioning of neighbouring dwellings and an understanding of the potential impact development could have upon them;

5.35 demonstrate that it will not result in inappropriate overshadowing, a loss of privacy or have an oppressive or overbearing impact on neighbouring properties;

5.36 provide a minimum of 10m between habitable windows and side elevations;

5.37 comply with the 45-degree rule set out within the BRE guidance;

5.38 comply with the 25-degree rule set out within the BRE guidance;

*Note: All design principles are applicable to all scales of development unless otherwise specified; *minor applications, **major applications*

Side extensions

88. Side extensions should normally be set back from the front of the house to retain the proportions of the original building and reduce the visual impact between existing and new development. This can be particularly important on symmetrical properties or identical semi-detached properties. The original building should remain the visually dominant element of the property (whether it is an extension, self-contained annex, an outbuilding or a garage).
89. Side extensions should avoid development, where extending at two stories or above, up to the site boundary, this results in a 'terracing effect', impacting the quality of the street scene and necessary access/maintenance.
90. Extension should maintain a gap between the extension and the site boundary or have a lower ridge height than the main building. The extent of the gap should be determined by the pattern of development in the area; however, gaps should be no less than 1 metre wide for the benefit of access and maintenance.
91. An alternative way of avoiding a terracing effect is to set the first-floor element of the extension back from the front elevation – it should be set back at least one third of the depth of the dwelling.
92. Two storey extensions should generally be constructed with the same angle of pitch as the existing roof, particularly where development is at the same ridgeline
93. Single storey side extensions will have a lesser impact on the appearance of a dwelling than two storey extensions. A flat roof may be acceptable for a single storey extension, provided it is carefully designed – e.g. including a parapet wall with a coping stone on top.

Key:

Acceptable in principle

Example of modest single-storey extensions in line with permitted development. Subservient in scale and massing. Best practice is to setback development to preserve the principal dwelling and maintain its character. Development should not be forward of the principal elevation. Materials and detailing should match the principal dwelling.

Potentially acceptable in principle

Example of a one and a half-storey extension. Subservient in scale and massing, setback to preserve the principal dwelling. Modest skylights or dormer windows can be acceptable. Materials and detailing should match the principal dwelling.

Unlikely to be acceptable in principle

Example of a two-storey extension. Roofs must match the existing dwelling, and not exceed the finished ridge and eave height. Flat roofs should be avoided where possible. The proportion and rhythm of window or door openings should be in line with the principal dwelling. Development must not be overbearing in scale or massing compared to the principal dwelling. Infill between buildings must not have a terracing effect.

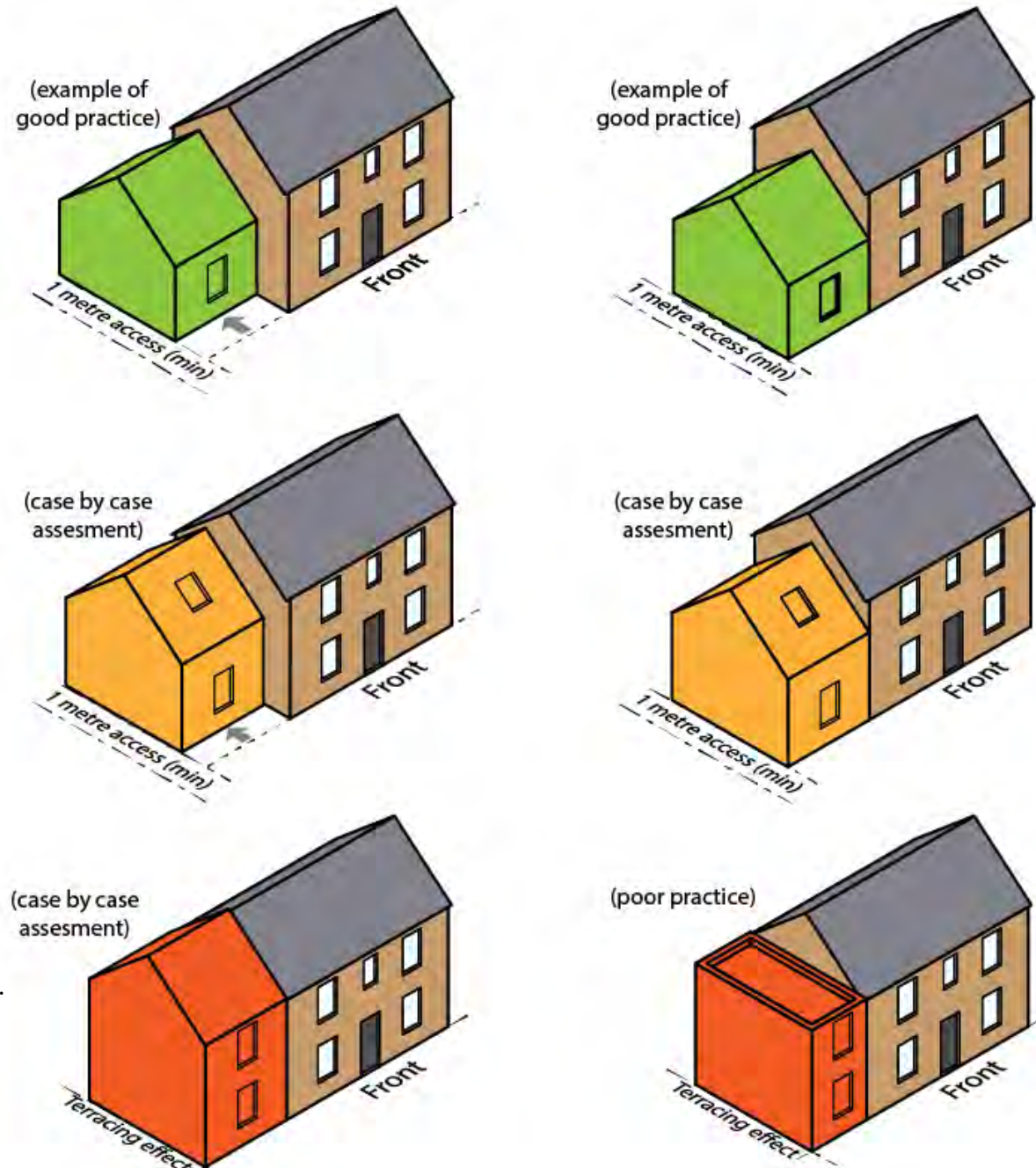


Figure 43: Side extensions, illustrative examples

Design principles - side extensions

Ensure the scheme:

- 5.39** is subservient to the principal dwelling;
- 5.40** is significantly set back from the front of the house (at least one third of the depth of the dwelling) and set down from the original roof ridge of the dwelling, or otherwise be justified for not doing so;
- 5.41** retains important gaps within the street scene and avoid creating a continuous building line. To reduce such a 'terracing effect', it is desirable to maintain a gap between the extension and the site boundary and for the extension to have a lower ridge height than the main building. The extent of the gap should be determined by the pattern of development in the area but, in general, it should not be less than 1 metre wide. An alternative way of avoiding a terracing effect is to set the first-floor element of the extension back significantly from the front elevation;
- 5.42** is constructed with the same angle of pitch as the existing roof;
- 5.43** includes windows that face the street to provide passive surveillance;

5.44 demonstrates that it will not result in overshadowing, a loss of privacy or an oppressive or overbearing impact on neighbouring properties.

*Note: All design principles are applicable to all scales of development unless otherwise specified; *minor applications, **major applications*

Rear extensions

94. Rear extensions should not result in significant overshadowing of a neighbour's property. Rear extensions which are not visible from the street or public rights of way and do not negatively impact on neighbouring properties can be expressed in many forms, including through the use of contemporary architecture. In addition to the distance between properties, there are a number of solutions or more detailed design measures that can be employed to maintain privacy surrounding the placement and design of buildings. This could include appropriate positioning of windows (staggered or otherwise), arrangement of habitable rooms to reduce direct views; and creating varied floor levels. As a rule, extensions that alter the existing ridge of the roof or significantly alter the roof profile will not be accepted where this detracts from the character and appearance of the original dwelling and / or the street scene.

Key:

Acceptable in principle

Example of modest single-storey extension in line with permitted development. Subservient in scale and massing. Best practice is to setback development to preserve the principal dwelling and maintain its character. Development should not be forward of the principal elevation. Materials and detailing should match the principal dwelling.

Potentially acceptable in principle

Example of a one and a half-storey extension. Subservient in scale and massing, setback to preserve the principal dwelling, modest skylights or dormer windows can be acceptable. Materials and detailing should match the principal dwelling.

Unlikely to be acceptable in principle

Example of a two-storey extension. Roofs must match the existing dwelling, and not exceed the finished ridge and eave height. Flat roofs should be avoided where possible. The proportion and rhythm of window or door openings should be in line with the principal dwelling. Development must not be overbearing in scale or massing compared to the principal dwelling. Infill between buildings must not have a terracing effect.

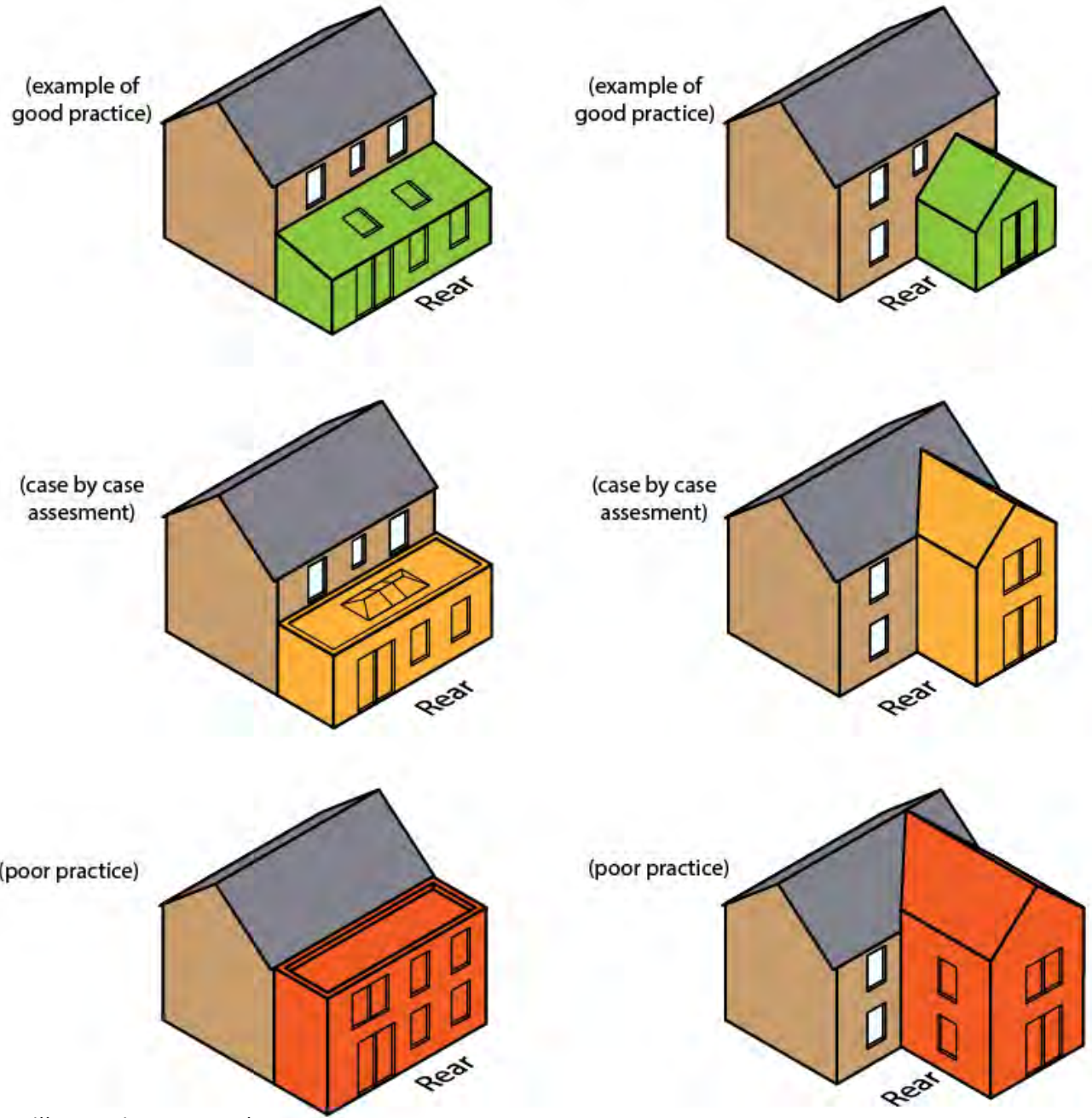


Figure 44: Rear extensions, illustrative examples

Design principles - Rear extensions

Rear extensions should:

- 5.45 avoid a detrimental impact on the existing dwelling's usable garden area;
- 5.46 not have a harmful effect on neighbouring properties in terms of privacy, overshadowing or overbearing impact;
- 5.47 provide an adequate distance between facing habitable rooms to help people feel comfortable in their homes;
- 5.48 comply with the 45-degree rule applying to two storey extensions only, as set out in this section.

*Note: All design principles are applicable to all scales of development unless otherwise specified; *minor applications, **major applications*

Front extensions, porches and canopies

95. Front extensions can often detract from the continuity of the street scene and damage the appearance of a dwelling.
96. Front extensions will be resisted where they have a significant impact on the street scene or are damaging to the appearance of a dwelling.
97. Where there is a prevailing rhythm to a series of buildings or strong building line, front extensions are unlikely to be acceptable.
98. Modest front extensions, where a building line is staggered or a dwelling is significantly set back from the road and reflects the character of the existing property, are more likely to be acceptable.
99. Front extensions should normally be designed with a pitched roof and match the main dwelling and its material.
100. Front extensions and porches should not become a dominant architectural feature and follow the same vernacular, material and detailing, including the size and rhythm of fenestration, including window casements and their style.

Key:

Acceptable in principle

Example of modest porch extensions in line with permitted development. Subservient in scale and massing, best practice is to preserve the principal dwelling and maintain its character. Materials and detailing should match the principal dwelling.

Potentially acceptable in principle

Example of a single-storey extension. Subservient in scale and massing, best practice is to preserve the principal dwelling and maintain its character, lean to extensions or dormer windows can be acceptable. Materials and detailing should match the principal dwelling.

Unlikely to be acceptable in principle

Example of a two-storey extension. Typically, larger front extension is unlikely to be accepted as they would substantially alter the principal dwelling. The proportion and rhythm of window or door openings should match the principal dwelling. Development must not be overbearing in scale or massing compared to the principal dwelling and the surrounding context and character, including any visual impact on the street scene.

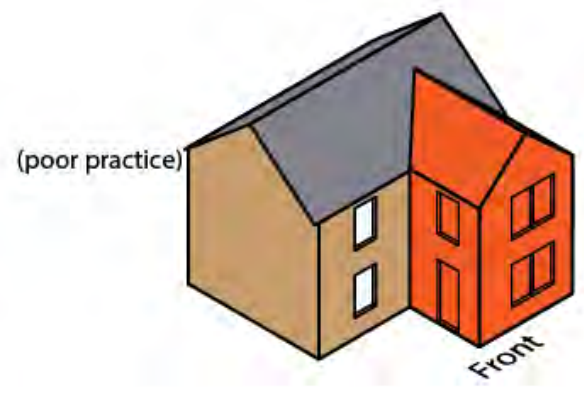
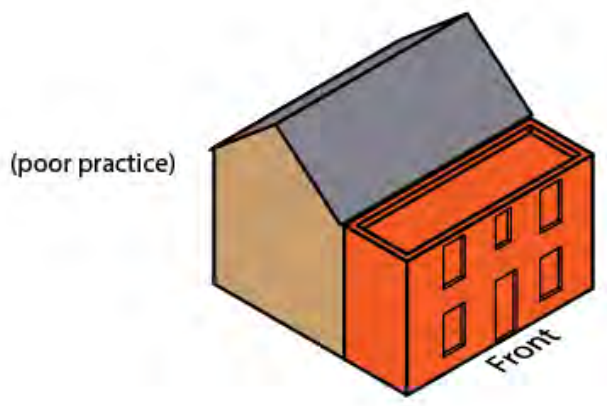
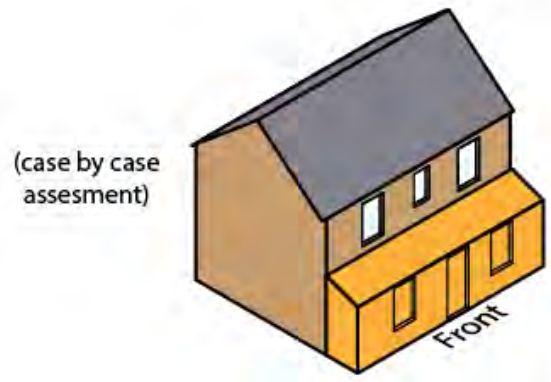
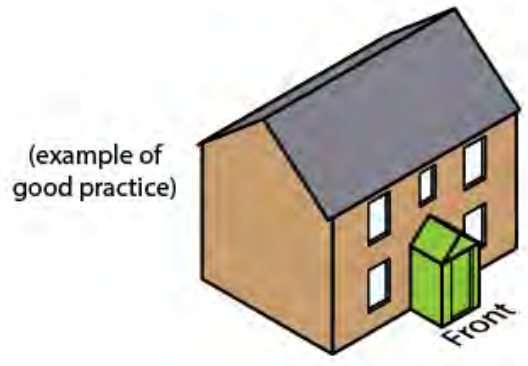
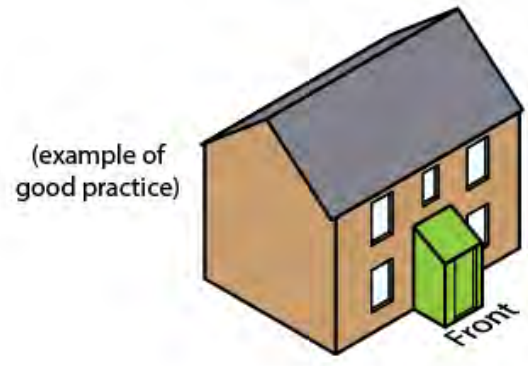


Figure 45: Front extensions, illustrative examples

Design principles - Front extensions, porches and canopies

Front extensions

5.49 Front extensions will be resisted where they have a significant impact on the street scene or are damaging to the appearance of a dwelling. Modest front extensions that reflect the character of the existing property are more likely to be acceptable. Large, flat-topped porches should be avoided. Where the building line is staggered or where the dwelling is set well back from the road, front extensions are more likely to be acceptable;

5.50 When located close to a neighbouring property, front extensions should not have a negative impact on the amount of light afforded to that property, nor should it have an overbearing impact;

5.51 Front extensions should not reduce the space available for parking below adopted standards outlined within Oxfordshire County Council Guidance.

*Note: All design principles are applicable to all scales of development unless otherwise specified; *minor applications, **major applications*

Loft and roof conversions

101. Loft conversions are a means of extending the existing living accommodation within a dwelling. As an enclosed space the main challenge of loft conversions is the introduction of roof lights or dormer windows for natural light and ventilation.
102. Dormer windows should be designed to sit evenly across the roof-slope and be set in from gable ends appropriately positioned between the eave line and ridge line. Two or three smaller dormers are often more successful than a single large dormer.
103. Dormer windows which extend a roof should be set within the roof slope. Where a clear rhythm of fenestration is established. Flat roofed dormers that fully occupy or extend the roof as a loft conversion should be avoided as they are considered visually detrimental and overbear to the massing of most dwellings.
104. Roof lights should follow the same principle, however, roof lights should not be positioned on the roof pitch of the front or primary elevation of a dwelling, as it detracts from the street scene.
105. Not all lofts are suitable for conversion, the pitch of a roof, width and depth of the building can limit the available space. All loft conversions require a minimum height of 2.2 metres, if your intended room has a sloping ceiling at least 50% of the floor area should achieve a floor-to-ceiling height of at least 2.1m.
106. Even if you have the required amount of headspace available in your loft, you may run into difficulties if you do not have enough space for a staircase up to it. Building regulations require a minimum of 1.9m of headroom at the centre of a flight of stairs, and 1.8m at the edges (where there will be sloping roofs). You will also need to allow space for the staircase on the floor below.

Key:

Acceptable in principle

Example of modest skylights and dormer windows forming a loft extension or conversion in line with permitted development. Subservient in scale and massing, best practice is to preserve the principal dwelling and maintain its character. The proportion and rhythm of skylights or dormer windows should match the principal dwelling. Materials and detailing should match the principal dwelling.

Potentially acceptable in principle

Example of larger or feature dormer windows forming a loft extension or conversion. These are to be considered in the context of local character and their visual impact. Subservient in scale and massing, best practice is to preserve the principal dwelling and maintain its character. The proportion and rhythm of skylights or dormer windows should match the principal dwelling. Materials and detailing should match the principal dwelling.

Unlikely to be acceptable in principle

Example of a full extension. Typically, larger front extension is unlikely to be accepted as they would alter the principal dwelling. The proportion and rhythm of window or door openings should match the principal dwelling. Development must not be overbearing in scale or massing compared to the principal dwelling and the surrounding context and character, including any visual impact on the street scene.

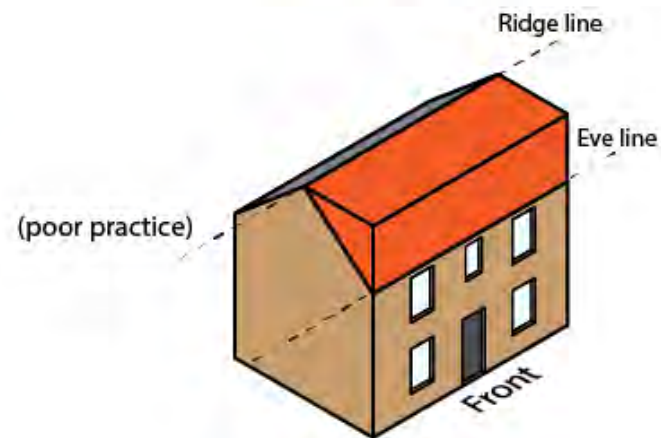
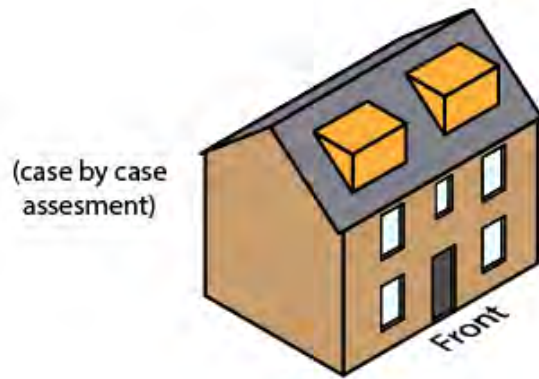
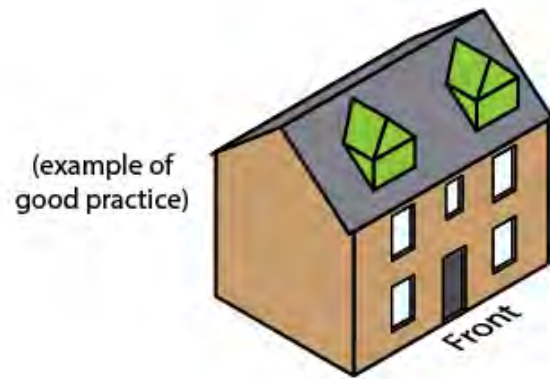
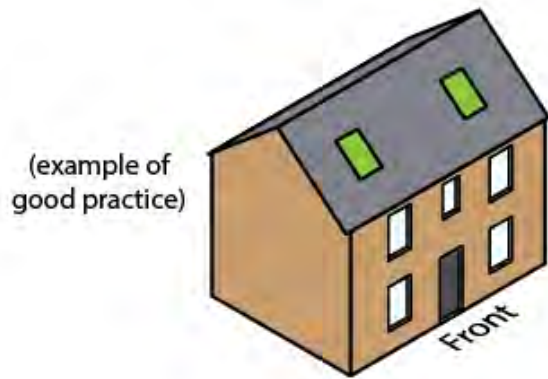


Figure 46: Roof extensions, illustrative examples

Design principles - Loft conversions and roof extensions

Loft conversions and roof extensions

5.52 Dormer roof extensions must be set within the roof slope. They should be designed as features principally to provide light and ventilation, and should sit well above the eaves line, well below the ridge line and should be set in from the gable ends. Dormer windows should not just be used as a means of generating additional headroom. The design should be informed by the character and appearance of the local vernacular;

5.53 The size, pitch and ridge height of dormers should be informed by the character and appearance of the existing building, and the local vernacular. The chosen design should complement the rhythm of the existing fenestration and roof pitch. The position and proportion of dormer windows should respond to existing windows and doors. Single, large flat roofed, box dormers must be avoided.

5.54 Roof lights should be used sparingly and where they are less likely to be visible in the street scene, such as to rear elevations or in discreet roof valleys. In sensitive locations, such as on Listed Buildings and in conservation areas, 'conservation type' roof lights should be used.

*Note: All design principles are applicable to all scales of development unless otherwise specified; *minor applications, **major applications*

Garages and outbuildings

107. These should follow the same general principles as extensions, principally the size and scale of any garage or outbuilding should not compete with the main dwelling.
108. The original building should remain the dominant element of the property whether you have one extension or several. The effect of any outbuilding should not overwhelm a dwelling from any given viewpoint.
109. The development of garages and outbuildings should not result in a significant loss to the private amenity area of the existing dwelling.
110. A single garage should be able to accommodate a car, storage and sufficient space for bicycles, with an internal floor area of 3 metres x 6 metres. A double garage should accommodate 6 x 6 metres.
111. Garages should not have domestic features or unnecessary fenestration (windows, domes or rooflights). The Roof design of a garage should generally follow the same orientation to the gable of the main dwelling or utilise a pyramid roof.

Annexes

112. These are to provide self-contained accommodation or to offer a degree of separation from the main dwelling. However, they usually need to be linked to the main dwelling, both physically and in terms of the inter-dependence of the use of the annex and the main dwelling.
113. Residential annexes should be designed in accordance with the advice for other residential extensions. In addition, they should share the front door and entrance hall of the main dwelling, and they should be designed to be capable of being incorporated into the main dwelling at a later date.
114. Caution should be exercised to ensure that the conversion of an existing outbuilding to an annex does not result in the creation of a new dwelling. Where there is no clear link with the principal dwelling, development is unlikely to be acceptable.

Key:

Acceptable in principle

Example of modest garages single or double, attached or setback in line with the principal dwelling. The scale and massing of a garage should be proportional to that of the principal dwelling to maintain its character. Roof pitch should be reflective of that of the principal dwelling. Materials and detailing should match the principal dwelling.

Potentially acceptable in principle

Example of detached single or double garages, in line with the principal elevation. Flat roof garages are potentially acceptable if they do not detract from the principal dwelling character. The scale and massing of a garage should be proportional to that of the principal dwelling to maintain its character. Roof pitch should be reflective of that of the principal dwelling. This includes when detached and set within the curtilage of a property. Materials and detailing should match the principal dwelling.

Unlikely to be acceptable in principle

Detached single or double garages, when forward of the principal elevation, need careful consideration when set within the curtilage of a property. These should flank the principal dwelling wherever possible. Flat roof garages are unlikely to be acceptable in this context. The scale and massing of a garage should be proportional to that of the principal dwelling to maintain its character. Roof pitch should be reflective of the principal dwelling. Materials and detailing should match the principal dwelling. Domestic features should be avoided in particular where they detract from the principal dwelling.

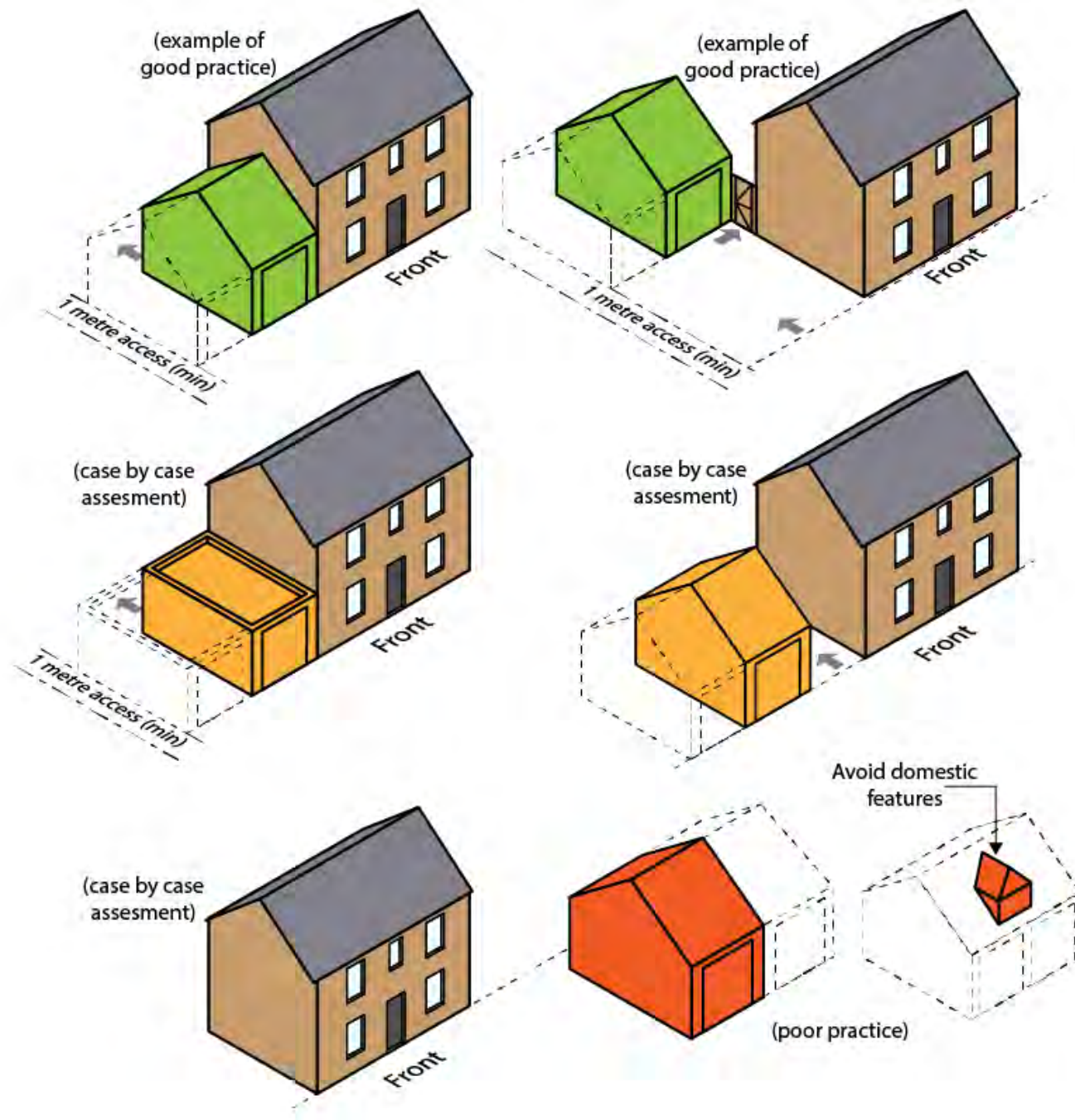


Figure 47: Garages, illustrative examples

Design principles - garages and outbuildings

Garages and outbuildings

5.55 Garages should be simple, functional buildings. They should be subservient to the main dwelling in terms of their scale, massing and height and should not include domestic features such as dormer windows (the standard size expected for garages to enable general storage are – internal dimensions of at least 6m x 3m for a single, 6m x 6m for a double);

5.56 Outbuildings should be visually subservient to the main dwelling when viewing the site from the wider surrounding area and should be sited so they do not dominate the character of the street scene;

5.57 Outbuildings forward of the principle elevation will only be acceptable where they do not disrupt a clear and legible building line along the adjoining highway and/or break up the existing sense of enclosure along the street.

*Note: All design principles are applicable to all scales of development unless otherwise specified; *minor applications, **major applications*

Rural and low density dwellings

Goal: Maintain a balance of local character and new development

115. Development in hamlets and within the open countryside is strictly controlled by government policy and local plan policy. This section is intended for rural villages and the countryside.
116. At this scale, landscape is the dominant feature with the buildings situated within the landscape or open countryside, their siting generally following the landscape for protection from the natural climate or as a by-product of a functional buildings use, i.e., agricultural buildings, estates or country houses.
117. Buildings in rural and lower density areas within South and Vale should be integrated into their landscape setting and site contexts in a sensitive manner. Buildings should not be located on ridgelines or exposed sites where the buildings will become a dominant visual feature to the detriment of the existing landscape character.
118. Applicants must demonstrate how the existing landscape and topography of a site has been considered from the outset of the design process as an integral part of any proposal.
119. Local character plays a critical role in the design process of development in rural and low-density areas. A contextual analysis should identify the local character of the development context in relation to the proposed design. The analysis should identify the scale, form, massing, architectural vernacular and materiality in and around the development's locality.
120. All development is expected to respect and incorporate the local character without being, pastiche or an overly simplified expression of the local character.
121. A sensitive and balanced approach should be taken when incorporating contemporary architectural designs. Applicants should include and integrate architectural features and materials of the local characters vernacular and material.

Figure 48: Identify local character and features when considering development in rural areas



Steps

Inform your design:

Undertake a contextual analysis (character study) of the development context, this should:

- Identify the character and pattern of development along the street;
- Identify the prevailing materials and architectural vernacular of the street;
- Identify the immediate scale and massing of neighbouring buildings;
- Identify the current curtilage and applicable boundaries treatments;
- Provide technical surveys where necessary, i.e., Tree survey.

Communicate your design:

Provide clear site sections and or a topographical survey where applicable;

Provide a site plan clearly identifying the existing building and the proposed extension;

Provide clear elevations, all applicable floor plans and a roof plan;

Three dimensional models where applicable;

Provide clear landscape plan demonstrating the retention of exiting features and planting.

Support your design:

[National Design Guide \(2019\)](#)

[National Design Code Part 1: The Coding Process \(2021\)](#)

[National Design Code Part 2: Guidance Notes \(2021\)](#)

[Chilterns Buildings Design Guidance](#)

[BRE guidance](#)



Understanding rural character setting



Rural dwelling set within the landscape (top); traditional informal farmyard cluster (bottom)



Rural buildings generally conform to simple forms (top); and in a rural context access should be designed and landscaped to be informal and have a minimal impact (bottom)

Examples showing a range of landscape character and setting in rural and lower density areas

Design principles - rural and low density

- 5.58** In rural lower density areas plot size should reflect the prevailing context. Visual gaps that reflect the general character of the immediate area should be retained between buildings on adjacent plots;
- 5.59** side boundary separation distances should take into consideration the character of the area and be reflective of surrounding plots;
- 5.60** In more rural and lower density locations front driveways are an acceptable solution and should be landscaped and designed in such a manner that they do not dominate the front garden or streetscape.

*Note: All design principles are applicable to all scales of development unless otherwise specified; *minor applications, **major applications*

Heritage and conservation

Goal: To make sure that buildings that are no longer used or vacant are re-used wherever possible in order to preserve their contribution to settlements and the countryside, in turn making it a more sustainable option.

122. There are many buildings throughout South and Vale within settlements and in the countryside that are no longer used or are vacant. These buildings include farm buildings, chapels, and schools. The reuse of existing buildings within South and Vale is a key objective in terms of preserving their contribution to settlements and the countryside but also in sustainability terms. The embodied energy in a building's fabric is considerable. For example, it takes a lot of energy to demolish and rebuild existing buildings. With this in mind, the council seeks to encourage the re-use of buildings wherever possible, particularly when the building makes a positive contribution to the character of an area. Their conversion and re-use, however, must be done with great care in order to ensure that the essential character of the original building is not lost or that the contribution the building makes to the wider area is not compromised.

Converting existing buildings worthy of retention

123. This section examines the design approaches that should be adopted when converting a range of existing building types. It should be noted that conversion to residential use is not always the most appropriate solution, particularly where the building is listed or is situated in an isolated location in the open countryside. Compliance with building regulations is also a key consideration for any building conversion and may require significant alterations to the original building. In these cases, the council may consider the conversion of the building as not appropriate or acceptable.

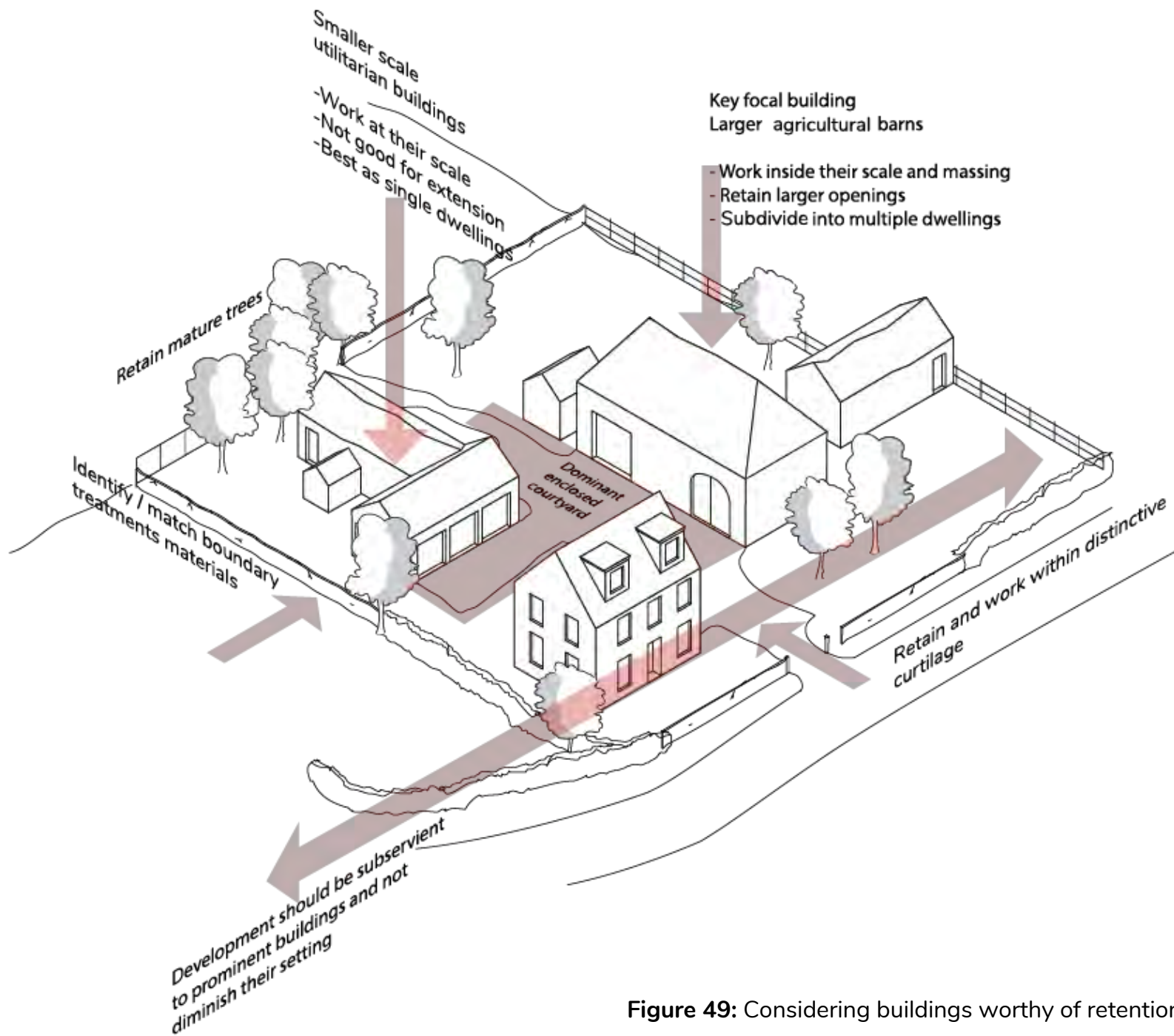


Figure 49: Considering buildings worthy of retention



Example of converted buildings (Crowmarsh Battle Farm)



Converted farm building (Crowmarsh Battle Farm)



Converted Chapel (Kingston Blount)



Successful barn conversions across the Vale

Design principles - Heritage and conservation

- 5.61** If the proposed conversion is within a conservation area or to part of a listed building, the proposed design must preserve or enhance the original features and/or contribute to its significance;
- 5.62** An assessment should be made as to the existing character and the impact of a proposed conversion on any special interest or designation, as per the NPPF, and through the contextual analysis;
- 5.63** The introduction of conspicuous domestic features should be avoided;
- 5.64** A structural report may need to be submitted with planning application (for agricultural buildings, factories, chapels, schools and mills, etc.) to demonstrate that the building is capable of conversion without substantial rebuilding or extension;
- 5.65** Existing openings in elevations should be used for windows and doors;
- 5.66** New windows or doors should be added sparingly and should not significantly alter the overall proportion of solid wall to openings;
- 5.67** Window types are in keeping with existing fenestration or a simple form is used as an appropriate alternative;
- 5.68** Where additional floors are introduced, they should not cut across or present an exposed floor edge to feature or ecclesiastical windows;
- 5.69** When appropriate, existing ecclesiastical fixtures and fittings should be retained;
- 5.70** When appropriate, existing commercial or industrial fixtures and fittings should be retained;
- 5.71** When introducing new materials, these should respond to established character and be compatible with both the existing materials and building type: for example, lime finishes, traditional weatherboarding, natural roofing and wall materials, etc.;
- 5.72** Consider adequately a buildings adaptation for existing and future users and changing circumstances (accessibility of the conversion);
- 5.73** Rural building conversions should be sensitive to the use of buildings by wildlife (ensure continued use by any species present) – particularly older buildings or those near to wildlife habitat;

5.74 In some cases, an extension may minimise harm in a listed building conversion by accommodating services and/or allowing significant spaces to remain open. In these cases, the proposed extension should be proportional to, complement and not detract from the original building.

*Note: All design principles are applicable to all scales of development unless otherwise specified; *minor applications, **major applications*

Traditional shopfront design

Goal: To make sure that shopfronts are in keeping with the character of the building and street scene, reflect the scale and proportion of the building in which it is set and preserve and restore surviving historic shopfronts in a sensitive manner.

124. The design details of traditional shopfronts have their roots in the display of goods in medieval market stalls, although the shopfront as we now recognise it emerged only with the expansion of commercial activity in the 18th century. Today we have a rich heritage of traditional shopfront design, particularly from the 19th and early 20th centuries.
125. Traditional shopfronts in South and Vale are increasingly threatened by the decline of the small individual retail outlets and the rise of larger stores with standard corporate images. However, it is possible to integrate the needs of retail units and pay regard to the character of the building or surrounding streetscape.

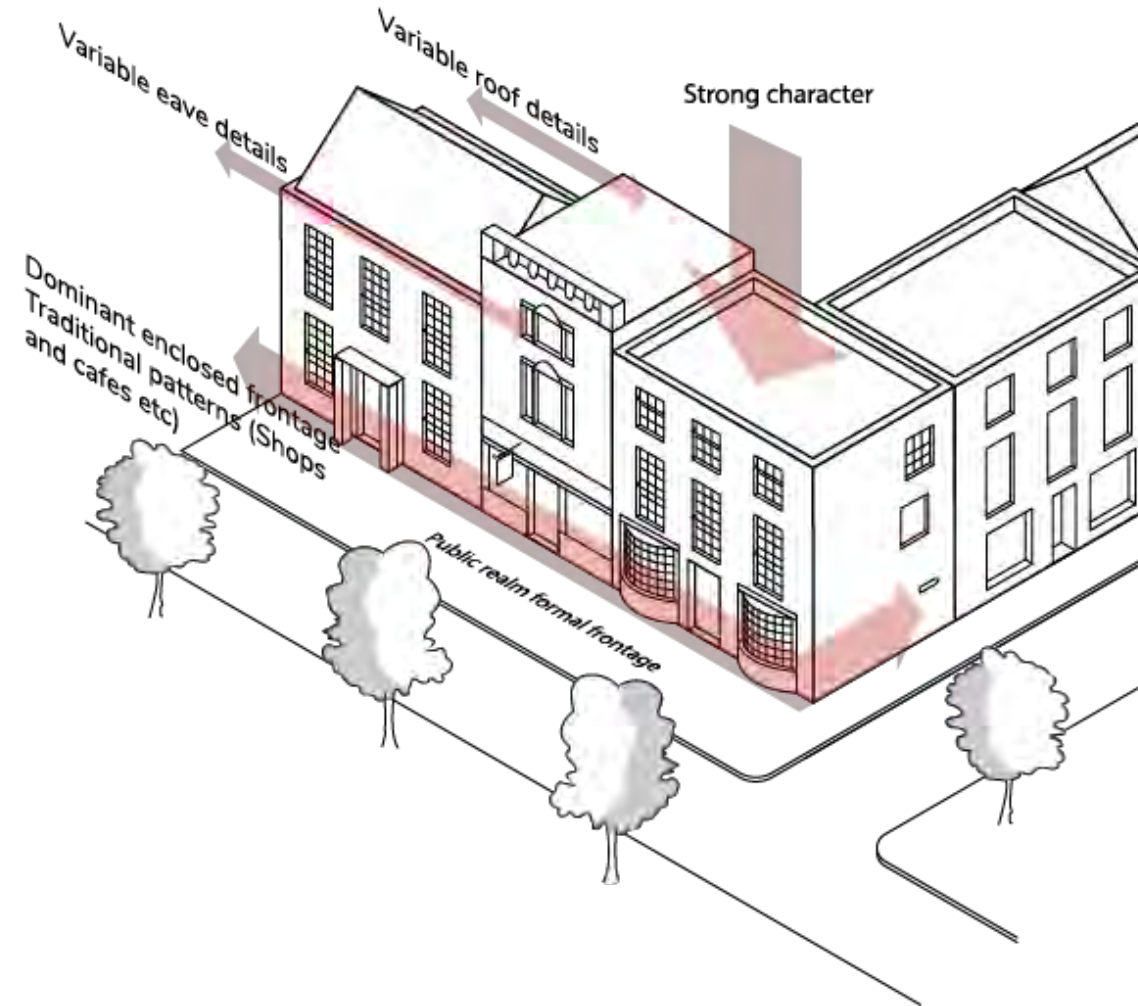


Figure 50: Traditional shopfronts along street

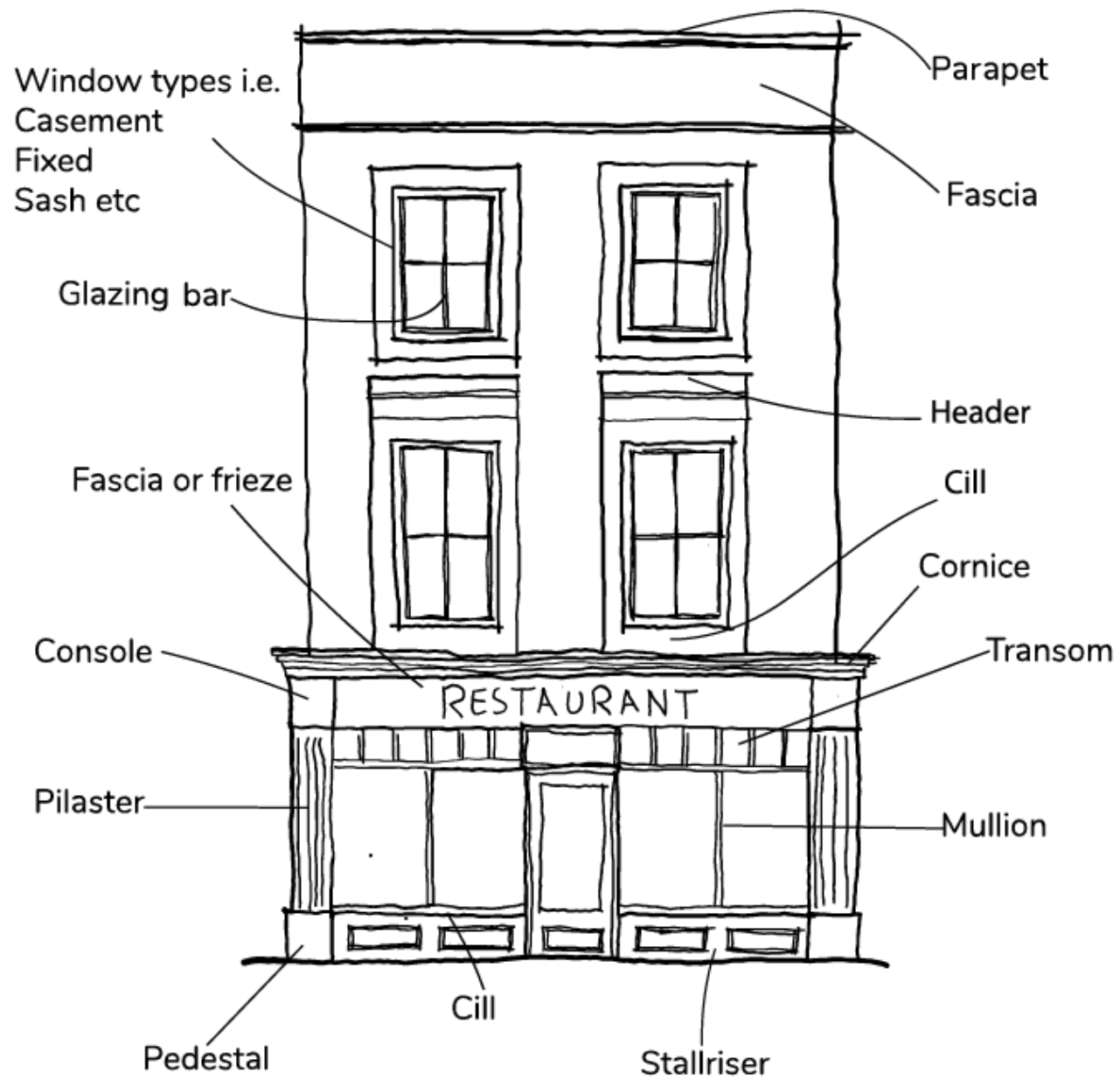


Figure 51: Traditional shopfront facades



Example of traditional shopfronts along a street (Thame)



Closer look to an example of a traditional shopfront (Thame)



3 Bell Street, Henley before refurbishment



3 Bell Street, Henley after refurbishment

Design principles - Traditional shopfront

Ensure your proposal considers the following:

- 5.75** The fascia, where the name of the establishment is displayed, should respect the proportions of the rest of the shopfront and the building in which it is set. It should not be too deep, wide or project forward from the face of the building, and should avoid illumination;
- 5.76** Pilasters and consoles should be used to support the fascia. They are sometimes decorated and often form an important part of the overall shopfront design;
- 5.77** Stallrisers provide a strong visual base to the shop window and can serve as additional security and protection;
- 5.78** Shop windows should generally be subdivided to achieve well-proportioned frontages respecting the building's age and architectural style. In some cases, glazing bars help to create visual relief, rhythm and an attractive design;
- 5.79** Doors are often recessed and have a solid lower panel which at least matches the height of the stallriser;
- 5.80** Materials should be in keeping with the character and appearance of the building;
- 5.81** Modern 'Dutch' blinds and canopies in plastic or similar materials which do not retract are often obtrusive to the appearance of the building and street scene and unlikely to be acceptable on listed buildings or in conservation areas;
- 5.82** Projecting and hanging signs, if they are necessary, should be small and traditional in design. Hand-painted signs hung from wrought iron brackets should be carefully positioned so as not to obscure details of the shopfront or other parts of the building;
- 5.83** When considering hanging signs over pavements, make sure they do not cause issues for people including with visual impairment;
- 5.84** Illumination of fascias and hanging signs is not encouraged in historic town centres and mixed-use areas where street lighting and shop windows should provide adequate light. Where necessary for late opening premises, it should be low key and discreetly positioned;
- 5.85** Alterations to historic shopfronts must balance the requirement to preserve historic character with the needs of adequate access;

5.86 Shopfront security can be very damaging to the character of the building and street. Sympathetic solutions, such as toughened glass, better internal lighting, internal video cameras and alarm systems can often be just as effective without the deadening effect of shutters and grilles;

5.87 Repair of traditional shopfronts should always be the first option, rather than their wholesale replacement;

5.88 The design of shopfronts in modern buildings, although allowing for innovation, should still reflect the basic principles of traditional shopfront design that have stood the test of time. New design should reflect both the character of the building and the street in which it is set;

5.89 Advertisement colours and lettering should not be garish but should complement the architectural style of the shopfront, the building and the character of the area where it is located.

*Note: All design principles are applicable to all scales of development unless otherwise specified; *minor applications, **major applications*

Non-domestic buildings

Goal: Well-designed buildings and spaces that respond to the needs of the users and contribute positively to the built environment.

126. It is well known that the way a building is designed affects the way we feel and respond to it. Better designed buildings and outside spaces will enhance the user's experience – this could be staff, visitors or customers, for example. There is, therefore, a direct link between the design of a building and the commercial success of a business using it.
127. Buildings must be designed appropriately for their function. However, they must also be designed to contribute to an attractive, safe and active environment that is sustainable for the future.
128. This guide will help to establish the key design and principles of any new industrial, commercial or retail development, to ensure that the buildings and spaces can be as effective and successful as possible and respectful of their setting.

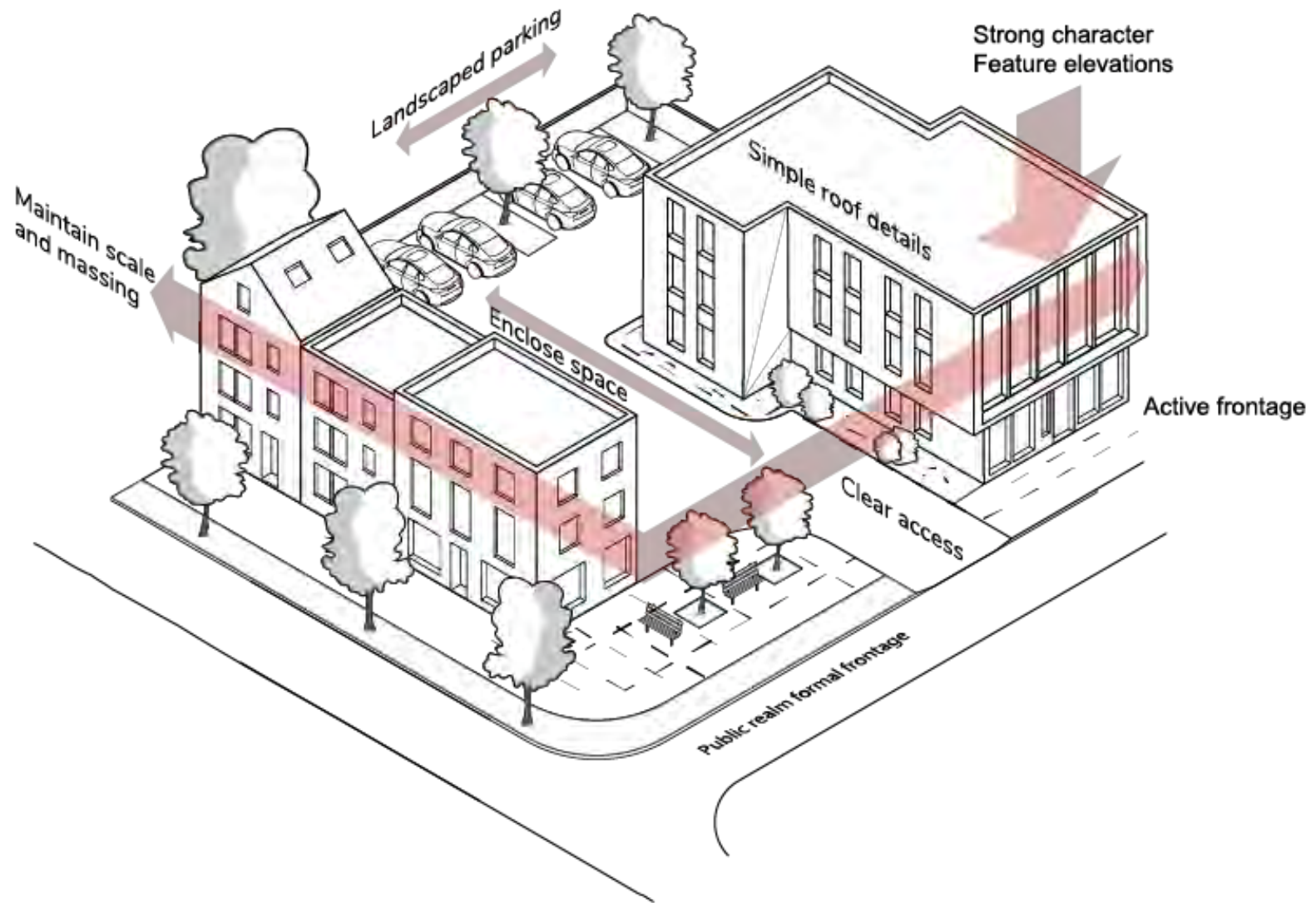


Figure 52: Considering non-domestic buildings in the built environment



Rowing Museum (Henley)



Cornerstone Arts Centre (Didcot)



Community centre (Didcot)



An example of non-domestic buildings (Milton Park)

Design principles - Non-domestic buildings

The development should ensure:

- 5.90** the layout of new employment areas should take a landscape and biodiversity-led approach focusing on investment in areas that will significantly contribute to the quality of the workplace environment;
- 5.91** commercial and employment areas are well served by frequent public transport. Proposals should be structured as a network of connected streets with development fronting the street wherever possible. Office areas and storage space within B2 and B8 uses must be integrated within the curtilage of a single structure and avoid low-quality ancillary buildings;
- 5.92** service yards should be internalised within the perimeter block to avoid fronting streets and the public realm. Large forecourts, with buildings substantially set back from the public realm should be avoided where possible. Wherever possible, large areas of surface parking should be positioned to minimise its impact on the public realm. This could include internalising the parking within the perimeter block, or locating it to the side or rear of the building;
- 5.93** limited parking can be provided in small forecourts accommodating visitor and disabled parking. The building line should maintain or establish a good street scene. Parking should be incorporated into the landscape design, with tree planting breaking up the visual impact of parked cars (including attractive, convenient and safe cycle parking and EV charging points);
- 5.94** that a range of appropriate, supporting facilities are incorporated within employment areas to serve the needs of employees and diversify occupation (night and day);
- 5.95** larger footprint buildings are broken down into a series of components to reduce their perceived bulk and massing. Articulation of the ground floor of buildings can create a more human scale and establish a coherent and common design language throughout the development;
- 5.96** standalone signage for individual businesses is avoided in favour of estate signage with unified boards, listing individual companies. Signage for individual businesses should be focused around entrance areas. Signage should not be overbearing or out of proportion with the overall building;

5.97 a Waste Strategy specific to the end use is provided. Each tenant should have access to adequate, hygienic space in which to segregate waste into various recycling streams and thus minimise landfill. These recycling points should be conveniently located for the users and also for the efficient removal of the materials by collection vehicles. These facilities must not be in plain sight of landscape areas or principle streets.

5.98 cater for electric vehicle charging points in conjunction with solar car parks and canopies to provide shade and shelter as well as energy generation.

*Note: All design principles are applicable to all scales of development unless otherwise specified; *minor applications, **major applications*

Mixed use development

Goal: Mixed use development or neighbourhood centres should be designed as a focus for the community.

129. Mixed use centres or neighbourhood hubs should be designed as a central focus for the community. They should provide an attractive and identifiable environment, supported by high quality public realm treatment including street furniture, materials, lighting and planting. All development within the centre should front onto the public realm and make a positive contribution to natural surveillance, identity and legibility.
130. Providing a public space will create a more welcoming pedestrian environment suitable for pavement cafés and a place for people to linger or meet friends. Setting the public space back from the road will reduce the intrusion of vehicles.
131. The clustering of buildings and the scale and massing of the centre or hub should contribute to its legibility. The heights and form of buildings will depend on their location within the district and the size of the proposed development. For example, within a more rural village location a neighbourhood hub could consist of two or three 2-storey buildings clustered around a key node whereas in more urban locations or within larger urban extensions it may be appropriate to structure a number of 3 – 4 storey buildings, a school building and crèche around a public space.
132. Make sure to include residential development within mixed use centres. This should be above to ensure activity and surveillance throughout the day and night. Residential proposals within these locations should consider service yard locations, noise, odour, lighting and air quality issues.

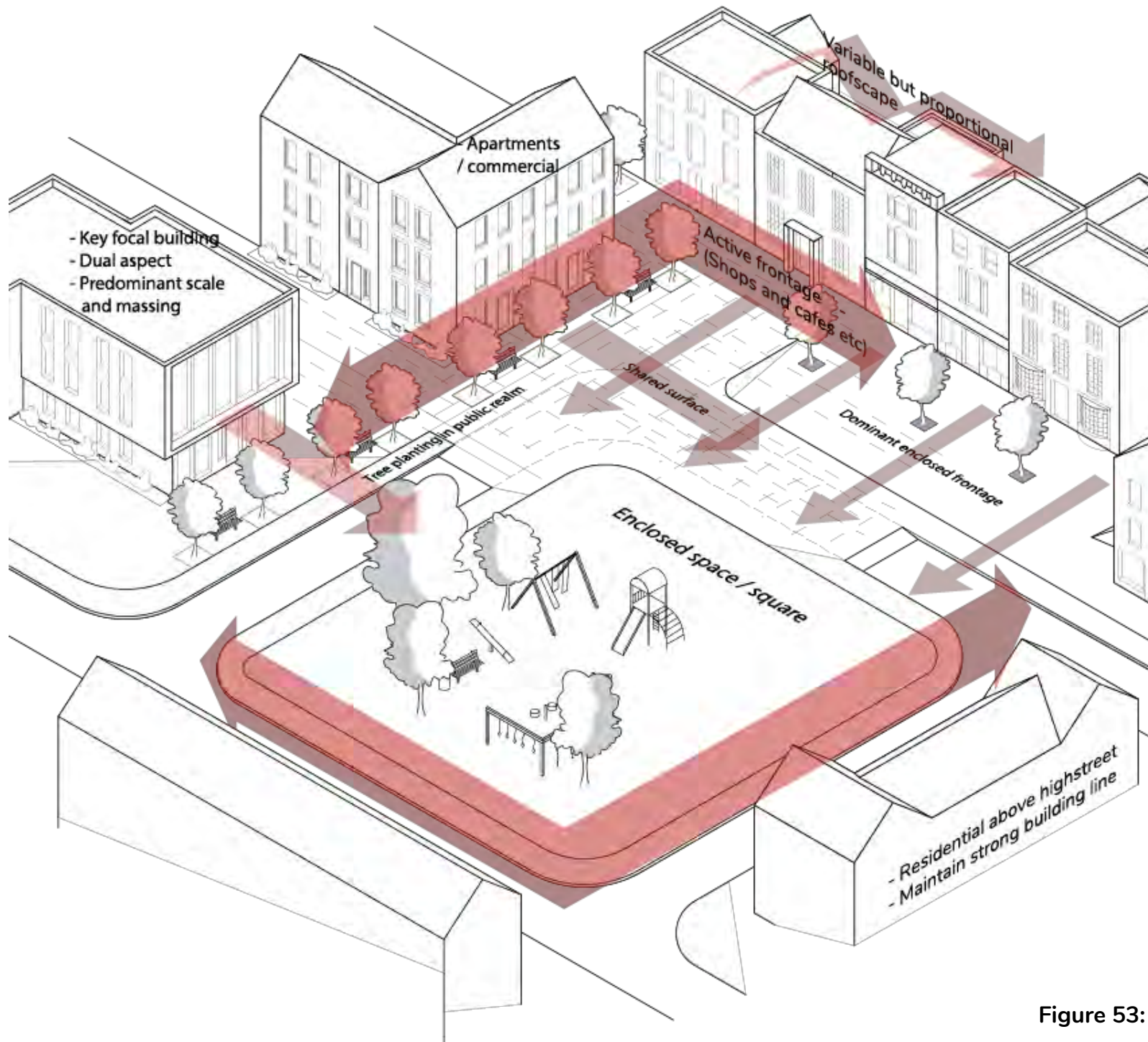


Figure 53: Mixed use centres



Village green



Residential square / green



Market square



Town square / centre

Figure 54: Examples of squares



Commercial and retail mixed use (Didcot)



Commercial and retail mixed use (Didcot)



Market square (Thame)



Town centre (Wallingford)

Design principles - Mixed use development

The development should ensure:

- 5.99** the location of mixed-use centres and community hubs are conveniently located at the intersections of a well-connected network and be highly visible. Accessibility for all users is integrated into the design of the centre with frequent public transport conveniently located and well-overlooked. Short stay, visitor and disabled car parking spaces alongside secure cycle parking are included. Service areas must not visually dominate or be present in an active frontage;
- 5.100** mixed use centres and community hubs are designed around clustered facilities fronting onto the high-quality public realm as a focal point. Avoid internal shopping centres or malls fronted by parking areas;
- 5.101** the height of buildings within a centre should be appropriate to its context and aid legibility;
- 5.102** include residential development above non-residential uses to ensure activity and surveillance throughout the day and night. Residential proposals within these locations should consider service yard locations, noise, odour, lighting, security and air quality issues;
- 5.103** active frontage should include increased ground floor ceiling heights to provide more generous non-residential spaces;

- 5.104** 'wrap' or locate larger non-residential footprints such as supermarkets or leisure buildings within blocks with a perimeter of active frontage.

*Note: All design principles are applicable to all scales of development unless otherwise specified; *minor applications, **major applications*

Materials, maintenance, and management

Goal: A place that works well for everyone and will continue to work well in the future.

133. The way the building and the space between buildings will be used once the development is completed must form a critical part of the evaluation of a proposed design. This is to ensure that buildings and spaces are used appropriately, that they do not break down, the materials and landscaping do not fail and that potential issues through the use of a management or maintenance programme can be resolved by ensuring that the quality of the development as planned is protected.
134. Good design is only successful if it is built to last. Spaces and buildings that are difficult or expensive to maintain will not achieve good, long-lasting quality in their design. Proper consideration must be given at the design stage to the effects of ageing, weather and climate conditions, normal wear and tear on buildings, streets and spaces, and landscape. Inadequate maintenance can lead to an environment just as poor as one that is badly designed in the first place. You should design for easy maintenance.
135. Designing for easy maintenance takes creativity and careful thought. It is not acceptable to use a cheap material, such as tarmac, just because it is easy to replace. Equally, think carefully about how a particular material such as paving will be replaced, should it need to be. Developers/applicants may be expected to make financial contributions to maintenance as necessary.



Natural Welsh slate



Brown / red handmade clay tiles



Brick-laying



Multi cladding



Brickwork detail



Pantiles (mottled colour)



Combed wheat straw or long straw



Horizontal wood cladding



Vertical wood cladding



Decorative wood cladding



Light framing (studs) with brick



Light framing (studs) with render



Stone



Flint detail



Brick and render

Figure 55: Use local materials in either a traditional or contemporary way



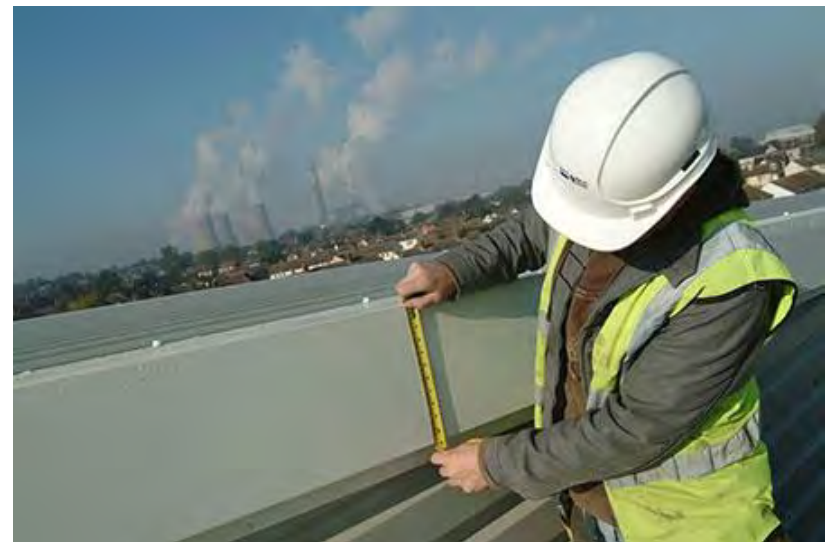
Hard wearing and long-lasting buff block paving (Thame)



Robust weather resistant knapped flint (Wallingford)



Provide a choice and variety of materials which should be inspired by the contextual analysis



Ensure good specifications and quality finishes

Design principles - Materials, maintenance, and management

The new development should ensure:

- 5.105** the choice of materials and detailing for the streets/spaces and buildings are inspired by the contextual analysis and local vernacular;
- 5.106** the visual impact of materials especially roof and brick colour. Visually recessive colours are encouraged in areas visible to the wider countryside;
- 5.107** it presents visual interest, created by attractive detailing, high quality materials, depth and relief, shadow lines and fenestration. Changes to texture and colour should be encouraged to complement the façade articulation across the envelope of the building, not just individual elevations;
- 5.108** materials used are proven to be sustainable, robust and weather well. Explore case studies/examples of where these materials have been used elsewhere to support your choice, including carbon credentials;
- 5.109** it provides an accompanying palette of materials for streets and spaces to complement building materials. These should be easy to maintain;
- 5.110** the approach to maintenance is clearly set out and identifies who is responsible for all the various parts of the scheme. The list of responsibilities is likely to include the following: buildings, trees and soft landscaping, streets and open spaces, public art and sustainable drainage systems;
- 5.111** hard surface materials are appropriate for their intended purpose and technical requirements;
- 5.112** there is sufficient space to allow landscaping and planting to establish and thrive;
- 5.113** enough space has been provided so that existing trees will not be damaged and to avoid pressure from future residents to remove them in the future.

*Note: All design principles are applicable to all scales of development unless otherwise specified; *minor applications, **major applications*

Overview

What is sustainable development?

Sustainable development has many complex and interwoven dimensions to it that must be considered from the earliest stages of development, as the potential environmental impacts are significant.

The widely accepted definition of sustainable development is:

“...development that meets the needs of the present without compromising the ability of future generations to meet their own needs” (Brundtland Commission Report, 1987)

The built environment in the UK has a significant impact on our environment (based on evidence from London Energy Transformation Initiative, LETI):

45% of total UK carbon emissions (27% from domestic buildings and 18% from non-domestic);

72% of domestic emissions arise from space heating and the provision of hot water;

32% of landfill waste comes from the construction and demolition of buildings;

13% of products delivered to construction sites are sent directly to landfill without being used.

What is a Climate Emergency?

In May 2019, the UK Government declared a climate emergency and proposed amendments to the Climate Change Act 2008, following recommendations made by the Committee on Climate Change.

Background and legislation

Subsequently, in June 2019, parliament passed legislation requiring the government to reduce the UK's net emissions of greenhouse gases (GhG) by 100% relative to 1990 levels by 2050.

In November 2020, the ten-point plan for a green industrial revolution was published. The plan sets out the approach government will take to build back better, support green jobs, and accelerate our path to net zero.

Both South Oxfordshire and the Vale local authorities declared Climate Emergencies in 2019. Here are the climate action targets for the districts:

[South Oxfordshire - Climate emergency](#)

[Vale of White Horse - Climate emergency](#)

South Oxfordshire and the Vale are also both signed up to the carbon reduction targets of the Oxfordshire Energy Strategy, which committed to a 50% reduction in carbon emissions by 2030.

Climate emergency is also directly linked to other matters, such as declines in biodiversity.

Further information can be seen here:

[South Oxfordshire - Ecological Emergency](#)

What is net zero carbon?

Net zero carbon (NZ), or 'carbon neutral' refers to achieving a balance between the amount of greenhouse gas emissions produced and the amount removed from the atmosphere. In some circumstances offsetting might be used to achieve this. There are two different routes to achieving net zero, which work in tandem: reducing existing emissions and actively removing greenhouse gases.

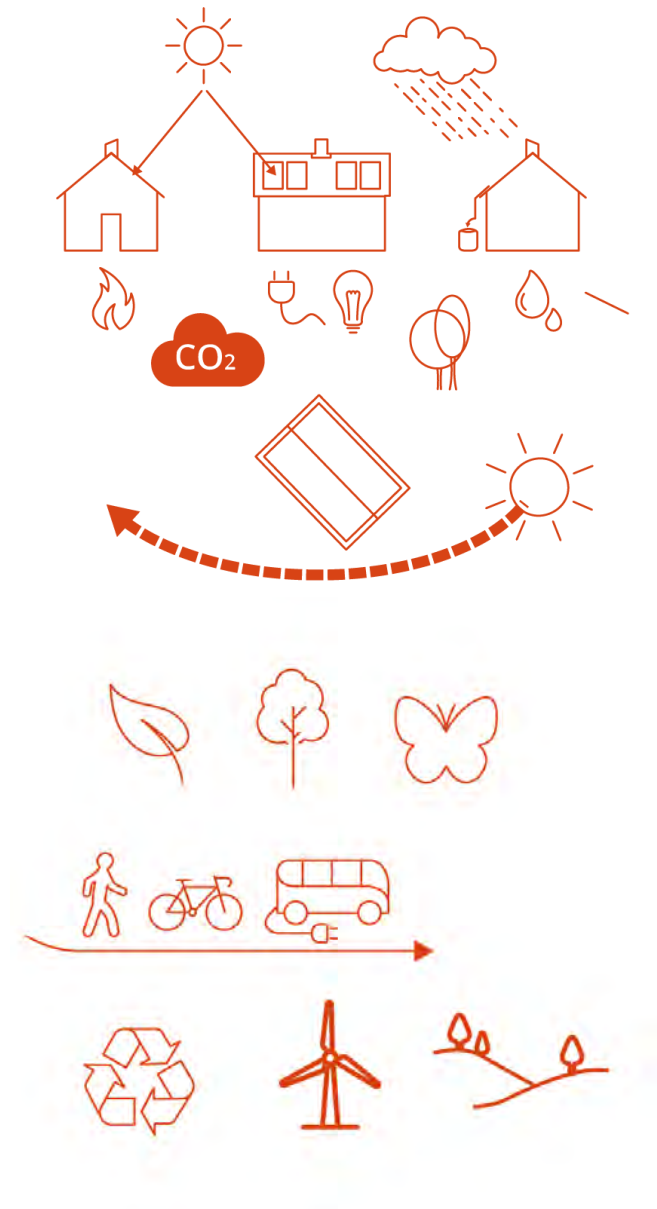


Figure 56: Issues to consider when designing to zero carbon

Sustainable Development – passive design

Goal: Achieve an optimal active design approach

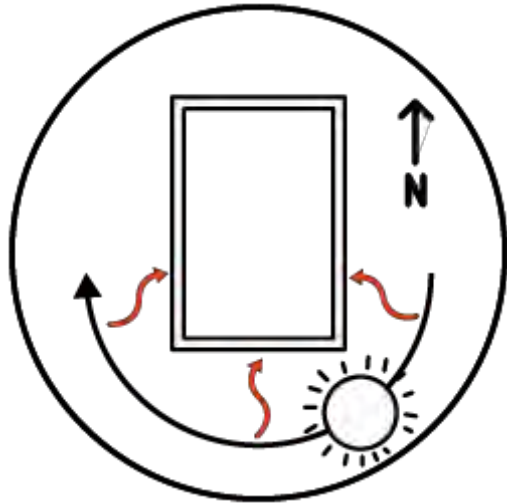
What do we mean by ‘passive’ design?

136. Passive design (not to be confused with ‘Passivhaus’ which is covered later) advocates design choices to maximise the efficient use of resources available from the natural environment. This can be for heating, cooling and ventilation in order to create comfortable conditions inside buildings. It can be achieved by harnessing environmental conditions, such as solar radiation, cool night air and air pressure differences to drive the internal environment. Passive measures do not involve mechanical or electrical systems.
137. Passive design choices are considered very sustainable as they emit no carbon and utilise the renewable resources of the natural environment. They also help lower the operational costs, require little to no maintenance and last the lifespan of a building.
138. You need to identify early on in the design process what passive design opportunities are available in a scheme and how these can be maximised. These should be considered not just for new development but also include refurbishment and upgrading of buildings, as well as expansions to buildings.

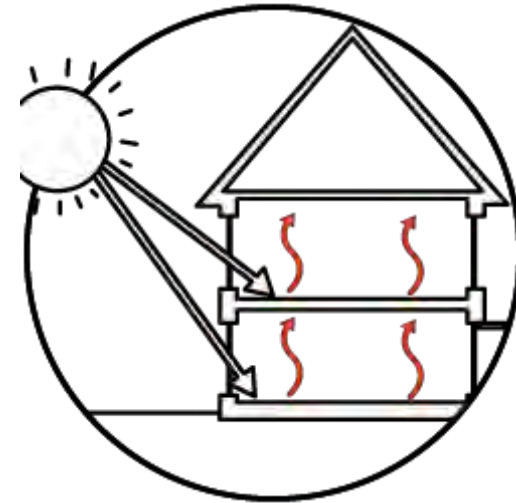
Factors to consider:

- Landscape
- Re-use of materials
- Siting / Orientation and Internal layout
- Scale and massing (thermal massing)
- Sunlight (lighting and solar radiation)
- Shading (natural and constructed)
- Passive ventilation

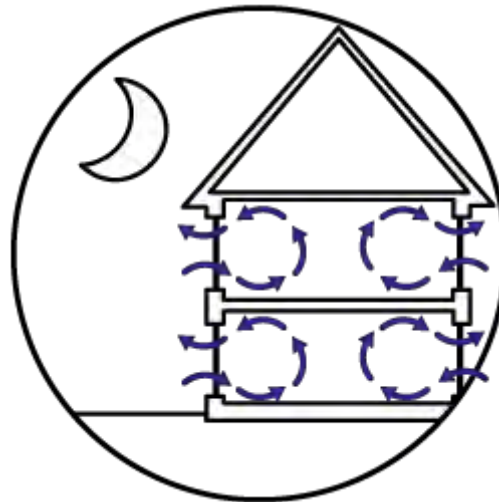
Passive design choices



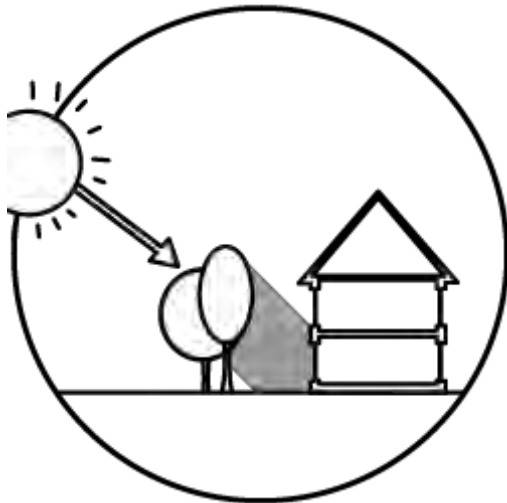
Orientation (South by South East)



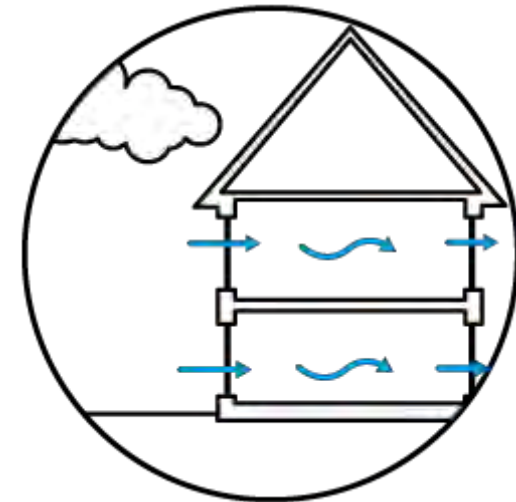
Use passive solar gain and thermal massing



Use night purging to cool



Use landscaping as natural shading



Use passive ventilation

Figure 57: Factors to minimise carbon emissions through passive systems

Sustainable Development – Active design

Goal: Achieve an optimal active design approach

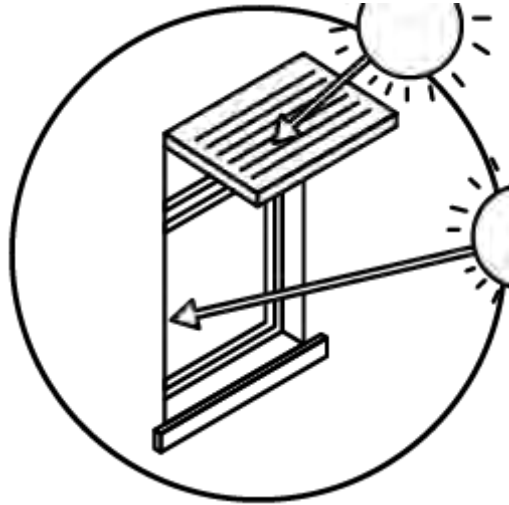
What do we mean by 'active' design?

139. 'Active' design uses mechanical and electrical systems (conventional electricity and natural gas) to keep the environment of a building comfortable. This includes the heating, cooling, lighting or heated water for a scheme or building. Buildings will generally include both active and passive measures. Active measures are considered less sustainable than passive design measures as they contribute to carbon emissions; however, they can utilise a mixture of renewable and non-renewable energy resources and be optimised to operate on more sustainable sources.
140. It is useful to identify early on in the design process, opportunities to minimise the carbon emissions of active systems by prioritising renewable energy sources rather than non-renewable ones.

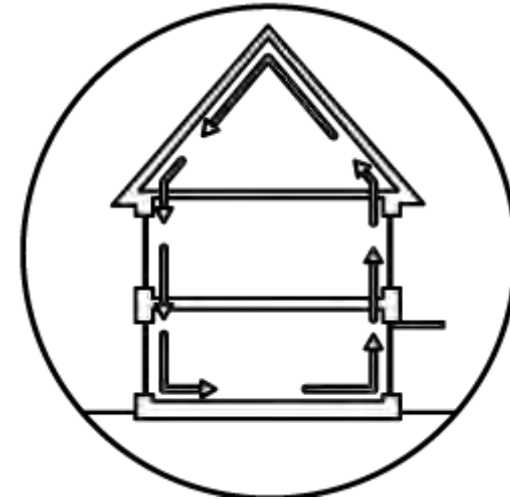
Factors to consider:

- Insulation
- Airtightness
- Solar-electrical power (battery storage)
- Solar-thermal energy (thermal storage)
- High efficiency Heating, Ventilation and Air Conditioning systems (HVAC)
- Air Source Heat Pumps (ASHP)
- Ground Source Heat Pumps (GSHPs)
- Water Source Heat Pumps (WSHPs)
- Electric charging (vehicle charging)
- Active design choices

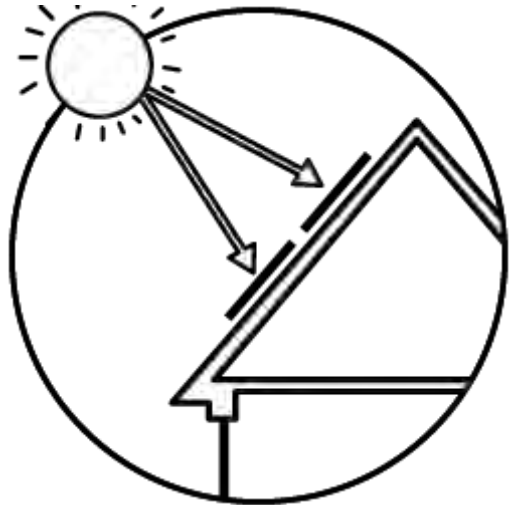
Passive design choices



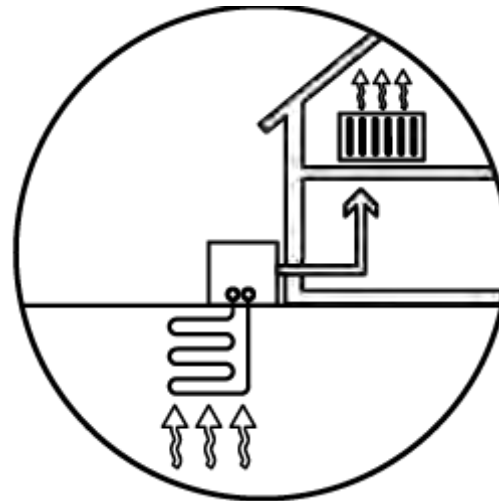
Thermal resistances and shading



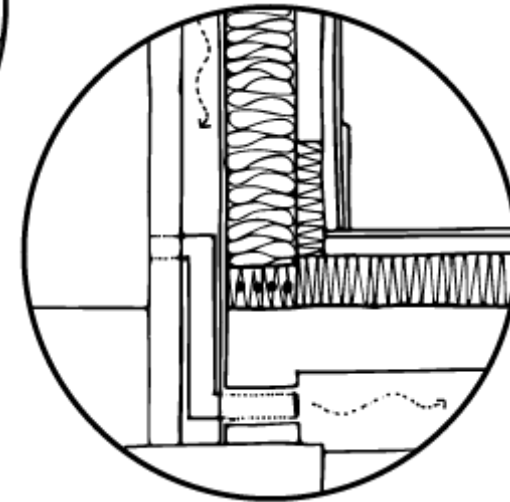
Airtightness



Solar electrical power



High efficiency Heating



Insulation

Figure 58: Factors to minimise carbon emissions through active systems

What to consider in your design approach?

141. Capturing waste energy in the form of heat or using smart local energy networks to distribute excess on-site energy where demand is needed, can also be used as an active approach to these systems.
142. Consideration should be given to linking energy solutions with large consumers (or generators) adjacent to the site, particularly where an infill site is concerned.
143. This may give an energy scheme sufficient scale to merit a more sustainable and economically sound approach to be realised.
144. An energy plan/ statement should be prepared and demonstrate how sustainable technologies might be used with, or instead of, more conventional forms of energy, such as natural gas.
145. Provide the maximum opportunity to incorporate active solar energy systems (either thermal or for power generation) thereby reducing energy demand.
146. Technologies to be considered within the plan should include (but not be limited to): solar photovoltaics (PV), solar thermal, heat pumps (air, ground or water if near a watercourse or river), hydro, wind and fuel cells.

A balanced approach

147. Development should demonstrate a balanced design approach to achieve sustainability, factoring in both passive and active solutions whilst considering local character. Consideration should be given to linking energy solutions with large consumers (or generators) adjacent to the site, particularly where an infill site is concerned.
148. As a rough guide the key aspects to consider using both passive and active design approaches to sustainability include:
 - Existing built fabric should be re-used as much as possible;
 - For new construction, minimise the number of resources, including energy needed as well as minimising waste;
 - The materials used for construction are sustainable, low carbon and locally sourced or manufactured;
 - Buildings use or have the potential to use renewable energy sources;
 - The design of a building is optimised towards energy efficiency;
 - Buildings have a long lifespan and can be easily adapted or re-purposed.

Examples of design responses

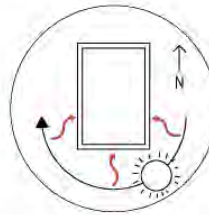
- Orientation: Orientation, layout of habitable rooms, and window size should be carefully considered in relation to the sun path.
- Rooms that are most frequently occupied should benefit from a southerly aspect with appropriate measures to avoid overheating in place.
- Rooms that include a concentration of heat generating appliances (e.g. kitchens) or are less frequently occupied (e.g. bathrooms) should be located in the cooler part of the building, generally the northern side.
- Conservatories and atria can be used to assist natural ventilation in the summer by drawing warm air upward to roof vents and to collect heat during the spring and autumn.
- Deep projections that overshadow windows should be avoided, particularly on south facing elevations. Projections should be sized appropriately so that they provide shading from the sun during the hottest part of the year but allow solar gain in the colder months.
- A higher proportion of glazing on north facing elevations can increase natural lighting without significantly increasing solar gain, thereby minimising excessive heat gain.
- Where there is a chance that overheating could occur (e.g. due to large expanses of glazing on roofs and south facing elevations), design measures such as roof overhangs, brise soleil, external shuttering, photochromatic and thermochromic glass and a lighter colour palette can help.
- Zonal heating, ventilation systems and controls can be used allowing areas subject to high solar gain to occupy their own temperature control zone. Dynamic controls reduce energy waste.
- Use of materials to build in thermal mass to absorb excess heat during warmer periods and release it slowly during cooler periods (e.g. day/night, summer/winter).
- Buildings should be designed for passive ventilation: Cross ventilation with windows located on opposite walls and/or roof mounted turbines or wind cowls that assist with circulation of air by drawing air through windows or top floor openings and;
- passive stack ventilation (PSV) that uses pressure differences to draw in fresh air from outside should replace rising warm air which is released from the top of the building. A heat exchanger can be placed where the air escapes the building to reduce heat loss.

Combining active and passive design approaches to reduce the carbon emissions of a dwelling.

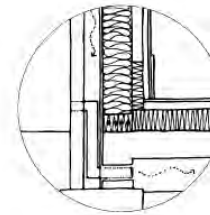
To see more technical guidance for homeowners on these aspects see:

[Planning Portal - common projects](#)

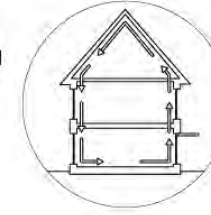
Factors to consider when looking to minimise carbon emissions and making a building more sustainable



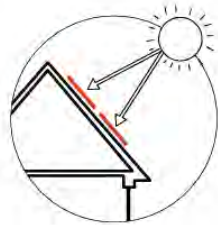
Orientation South by South East, or within 30 degrees South facing



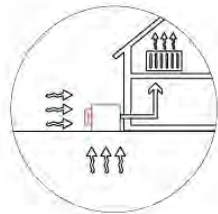
Insulation reduces heat loss and the energy required to heat or cool a building, reducing its carbon emissions.



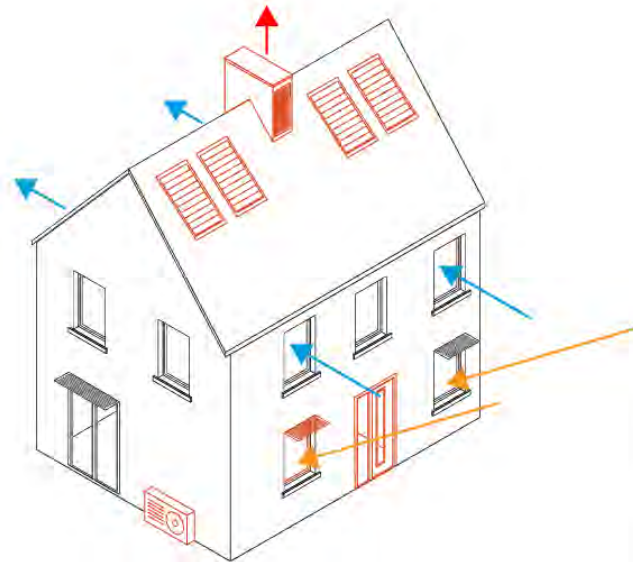
Airtightness in new buildings is a mandatory requirement of Building Regulations Part L. Excessive air infiltration can have serious implications on the operational energy use of a building.



The use of or installation of solar panels increases the sustainability of a building

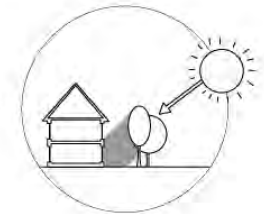


An air source (or ground) heat pump, transfers heat from the outside air, to heat or cool a building renewably, reducing its carbon emissions.

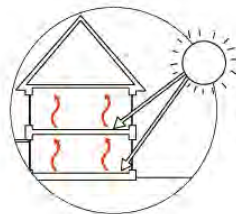
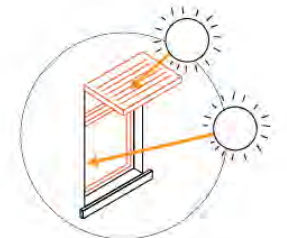


Passive stack ventilation (PSV) is a natural method of ventilating a building. It doesn't use electricity so helps reduce carbon emissions.

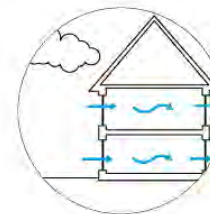
Use landscaping as natural shading



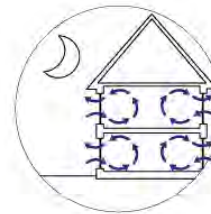
Energy-efficient glazing incorporates coated glass to prevent heat escaping through windows, improving the energy efficiency and reducing carbon emissions.



Use passive solar gain and thermal massing



Use passive ventilation



Use night purging to cool

Figure 59: Combining active and passive design approaches can reduce the carbon emissions of a dwelling.



Photovoltaics (Upton, Northamptonshire)



Ground source heat pump



Example of an extensive green roof (Maidenhead)



Passivhaus with Photovoltaics (Southmoor, from Greencore Construction)

Design principles - sustainable development

Ensure the scheme:

- 6.1 uses tree planting in open spaces and streets to mitigate heat island effects;
- 6.2 maximises the reuse and recycling of materials including materials existing on site;
- 6.3 optimises the orientation of buildings to utilise solar gain and shading;
- 6.4 optimises natural ventilation techniques to improve the wellbeing and comfort of internal environments and further reduce energy needs;
- 6.5 includes water harvesting and storage provision for all major and minor development types;

We strongly encourage:

- 6.6 the use of renewable energy technologies to reduce the site's conventional energy needs;
- 6.7 the use of solar technology on roofs for all commercial, non-commercial, industrial buildings, and solar canopies in parking areas **;
- 6.8 the use of solar technologies on roofs for residential developments;
- 6.9 the reuse and recycling of materials including materials existing on site.

*Note: All design principles are applicable to all scales of development unless otherwise specified; *minor applications, **major applications*

Reducing carbon emissions

Achieve the optimal design approach to minimise energy usage and reduce carbon emissions.

What are carbon emissions?

149. This is the carbon emitted through the energy used by a building; the heating, cooling, lighting, and water supply all require energy to be used to operate buildings (this is called operational carbon or carbon emissions). The fuel sources to provide these have traditionally been carbon-based energy generated by the burning of fossil fuels which emits carbon. Energy generation that relies on non-fossil fuels sources is known as renewable energy. Renewable energies are so called 'renewable' because they rely on natural fuel sources that do not diminish or can be replenished. Renewable energies do not emit the high levels of carbon that fossil fuels do, therefore they help reduce the carbon emitted into the atmosphere. This simply means that every time you turn on the heating or lighting in a building, less carbon is being emitted by process of generating the energy needed to make that happen. This makes the building more sustainable as it has lowered its carbon emissions by using renewable energy.
150. There are two distinctions around what constitutes the energy consumption and resulting emissions from a building, these are **regulated** and **unregulated** energy and emissions.
- **Regulated energy:** is energy consumed by a building and it's controlled, fixed services and systems, including heating, cooling, hot water, ventilation, fans, pumps and lighting.
 - **Regulated emissions:** are a buildings net CO2 emission, produced by the energy consumption from its controlled fixed services. Such systems are governed by limits set in Building Regulations. The net CO2 regulated emissions of a building fixed services can be reduced by applicable on-site sustainable energy generation; this can help reduce the carbon emissions of regulated energy, as a result reduce a buildings carbon footprint.

151. As a building's fixed services and systems, including heating, cooling, hot water supply, ventilation, fans, pumps and lighting, can be controlled by an architect, these items can be factored in and delivered sustainably with the design of a building.

- **Unregulated energy:** is the energy consumed by a building resulting from fixtures or appliances, these are not limited by Building Regulations. For example, this can include energy consumption from appliances integral to the building's operation/habitation e.g., lifts, escalators, refrigeration, external lighting, I.T equipment, general electrical items such as, TVs, kettles, microwaves, ovens, hobs etc.
- **Unregulated emissions:** are the emissions from these fixtures or appliances within a building. They constitute towards the buildings carbon footprint but cannot be directly controlled directly through design, either by the design of the building or limitation/prescription of what can be used.

152. As a building's fixtures or appliances, can all differ from building to building and are chosen by the occupant, an architect does not have control over them, therefore the energy used or required by fixtures and appliances cannot be factored or required to constitute towards the sustainable design of a building.

Regulated / unregulated energy and emissions

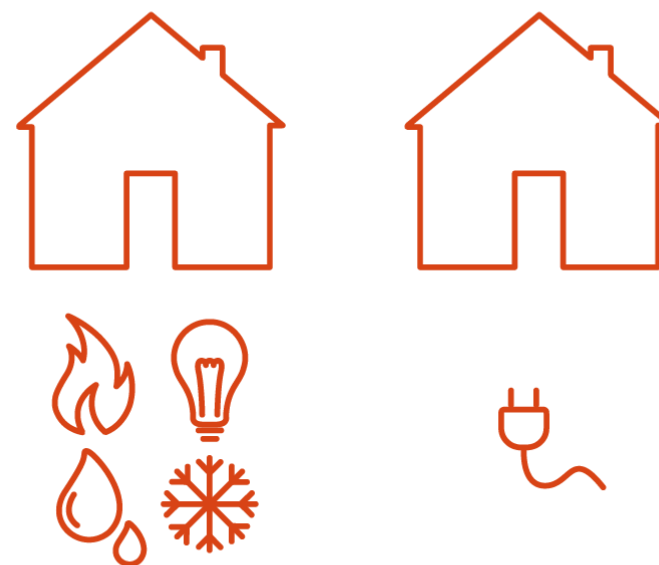


Figure 60: The two distinctions around what constitutes the energy consumption and resulting emissions from a building, these are regulated and unregulated energy and emissions

What to consider in your design approach?

153. The building's envelope is the main source and quickest route to de-carbonising a building, through the insulation of the walls, windows, roof and ground floor to the highest standards, to help reduce emissions.
154. Increasing the thermal efficiency of a building reduces the need for heat input, except for the coldest conditions. The most thermally efficient designs require the elimination of thermal bridging and an airtight building, mechanically ventilated, in order to maintain air quality and avoid cold spots and condensation.
155. Conversely, it is vital that the building design avoids overheating. The Chartered Institute of Building Services Engineers provides guidance on the avoidance of overheating risks in their Note [CIBSE TM59](#), which should be consulted.

Modern Methods of Construction

156. Modern methods of construction (MMC), using predominantly off-site fabrication to high standards, can play a significant part in achieving a reduction in emissions, if the choice of materials does not involve high energy input or excessive transport costs.
157. The adoption of MMC, however, should also have regard to the place, setting and character of a site.
158. Alternatively, the improved versions of the use of traditional and off-site materials and construction can yield very high levels of insulation, especially if their energy costs are lower. In some cases, the use of cob/mud brick, rendered and properly detailed, or rendered straw bale represent the emergence of a new local vernacular. The benefits of building with biomass, including sustainably sourced timber, as well as the above, can help 'lock in' already sequestered carbon.



NHBC Foundation Modern methods of construction (2018)



NHBC Foundation Modern methods of construction (2018)

Standards and Certifications

Goal: Achieve an applicable level of sustainable accreditation with your design

District requirements

159. There are additional requirements beyond Building Regulations in the adopted South Oxfordshire Local Plan 2011 – 2035.
160. South Oxfordshire District Council has ambitious aspirations for reducing the district's carbon emissions and is committed to becoming a carbon neutral district by 2030.
161. Policy DES10 of the Local Plan specifies requirements above those of the 2013 Building Regulations, these are set out below:
162. Policy DES10 requires a reduction in carbon emissions which steps up over time. For housing, it requires all new build residential dwelling houses, developments that include 1,000sqm or more of C2 use, and Houses of Multiple Occupation (HMOs) to achieve a percentage reduction in carbon emissions compared with the 2013 Building Regulations, starting at 40%.
163. It also requires a percentage reduction in carbon emissions for all other major non-residential development (1,000sqm or more). This is in addition to requiring all non-residential proposals to meet the BREEAM excellent standard.
164. These requirements apply to each individual dwelling and/or building and should not just be applied to the site as a whole, more detail is set out in the adjacent table.

South Oxfordshire Local Plan policy DES10

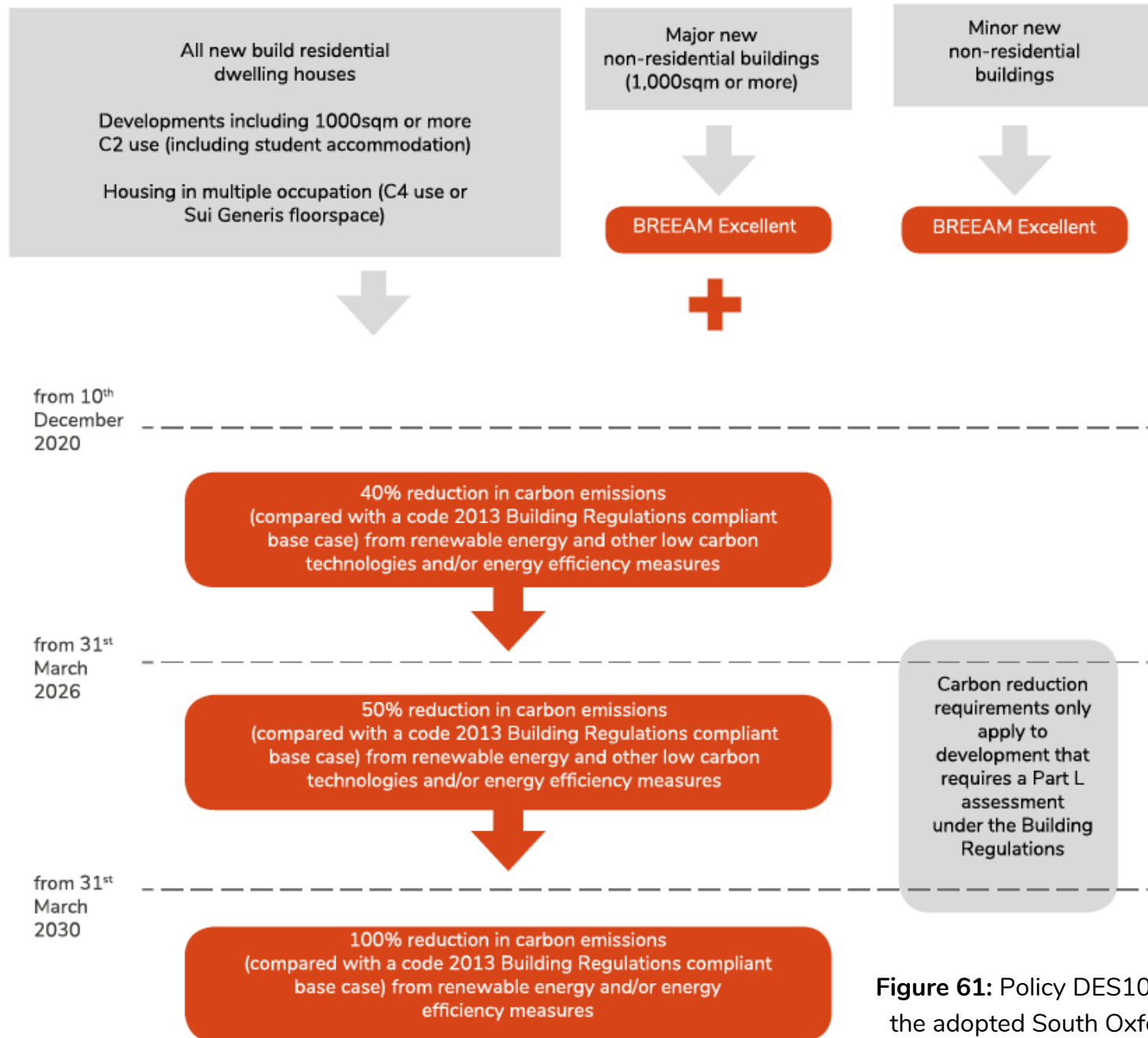


Figure 61: Policy DES10: Carbon Reduction from the adopted South Oxfordshire Local Plan 2035

BREEAM

165. BREEAM stands for the Building Research Establishment Environmental Assessment Method. This is an assessment method used to measure and mark the environmental performance of a development, based on its design, specification, construction and operation over its lifespan.

Developments are rated and certified on a scale of:

- Unclassified -30%
- Pass +30%
- Good +45%
- Very good +55%
- Excellent +70%
- Outstanding +85%

166. BREEAM benchmark compares an individual building's performance with other BREEAM rated buildings and the typical sustainability performance of new non-residential buildings in the UK

167. All new non-residential buildings within South Oxfordshire and the Vale are to meet BREEAM excellent standard. However, we understand that this may not always be appropriate due to the type of some developments and/or reasons of viability. For example, agricultural buildings that require planning permission and other buildings that may not require heating. In these cases, a request for a departure from BREEAM will need to be made and agreed between the applicant and the case officer. A statement setting out why the function of the building makes it inappropriate to meet the BREEAM excellent standard should be submitted as part of the application. A viability assessment will be required where an argument regarding viability is being made.

- Factors to consider as per BREEAM assessment criteria:
- Management
- Pollution
- Ecology
- Energy
- Water consumption
- Efficiency
- Materials
- Waste
- Transport
- Health and wellbeing

BREEAM benchmarks and scoring



Figure 62: The BREEAM rating benchmarks for projects assessed using the BREEAM International New Construction 2016

Passivhaus

168. Passivhaus is an energy performance standard for dwellings that can be adapted throughout the world. It was developed in Germany in 1990 and is primarily intended for new residential dwellings, although it can be applied to refurbishments or expansions.
169. As the name indicates, **Passivhaus** focuses on a passive design approach to sustainability whilst optimising the renewable energy sources for active M&E systems. Ideally all new residential buildings within South Oxfordshire and the Vale should aim for Passivhaus certification. However, we understand that this may not always be appropriate due to some development types and/or reasons of viability. In these instances, developments should seek an optimised and balanced approach, using passive and active design methods, to reducing their development's carbon footprint.

Factors to consider for Passivhaus:

- Above standard specification of insulation
- Air tightness
- Mechanical Ventilation with Heat Recovery (MVHR)
- Solar Gain (thermal massing)
- Controlling Solar Gain (shading, natural and constructed)
- Pre-emptive cooling of air
- Night purging of air
- Re-use internal heat sources



Passivhaus example (Shropshire)



Passivhaus example (Shropshire)

Design principles - Standards and Certifications

We strongly encourage:

- 6.10** A fabric-first design approach is prioritised for the built form and its envelope, focusing on airtightness, high insulation, passive ventilation and the incorporation of renewable energy systems and technologies;
- 6.11** modern methods of construction (MMC) are prioritised for the built form and its envelope;
- 6.12** high efficiency and ultra-low energy fixed building services or infrastructure to help reduce regulated emissions.

We support:

- 6.13** any development which goes beyond Part L Assessment under the Building Regulations;
- 6.14** Note: DES10 of the adopted SODC Local Plan requires a 40% reduction in carbon emissions (compared with a code 2013 Building Regulations compliant base case, from renewable energy and other low carbon.
- 6.15** all non-residential development aspires to meet BREEAM excellent standard**;

Note: DES10 of the adopted SODC Local Plan requires all non-residential proposals meet BREEAM excellent standard, unless mitigating circumstances can be demonstrated.

Reducing embodied carbon

Goal: Achieving optimal design and construction to reduce embodied carbon

What is embodied carbon?

170. This is the material used to construct a building, how these materials are transported to the construction site, and how these materials were originally made or extracted as raw material (this is called embodied emissions). Many different materials can be used for erecting a building. Some examples are steel, timber and concrete. Each material has a different carbon footprint;

What design approach to take:

171. Applicants are encouraged to minimise the embodied carbon of a building, focusing on its material fabric. This is because typically the materials that form the fabric of a building account for the largest amount of embodied carbon. The material fabric of a building refers to the physical elements separating the indoor environment from the outdoors, consisting of the frame, structure and insulation that make up the foundations, walls, floors, and roof;

172. Minimising embodied carbon through the material fabric of a building can be achieved by re-using materials and structures, or limit carbon-intensive materials;

173. Combining the operational and embodied carbon emissions for a building over its expected lifespan amounts to understanding the whole life-cycle of its carbon emissions. To understand this, you should undertake a 'Whole life-cycle carbon assessment' (WLC assessment). WLC assessments help to provide a real understanding of the sustainability of our design choices and their impact on the environment;

Factors to consider:

- Construction
- Operational energy
- Reduced construction impacts
- Scale and massing (thermal massing)
- Increase renewable energy supply
- Carbon offsetting

Whole life-cycle carbon assessment

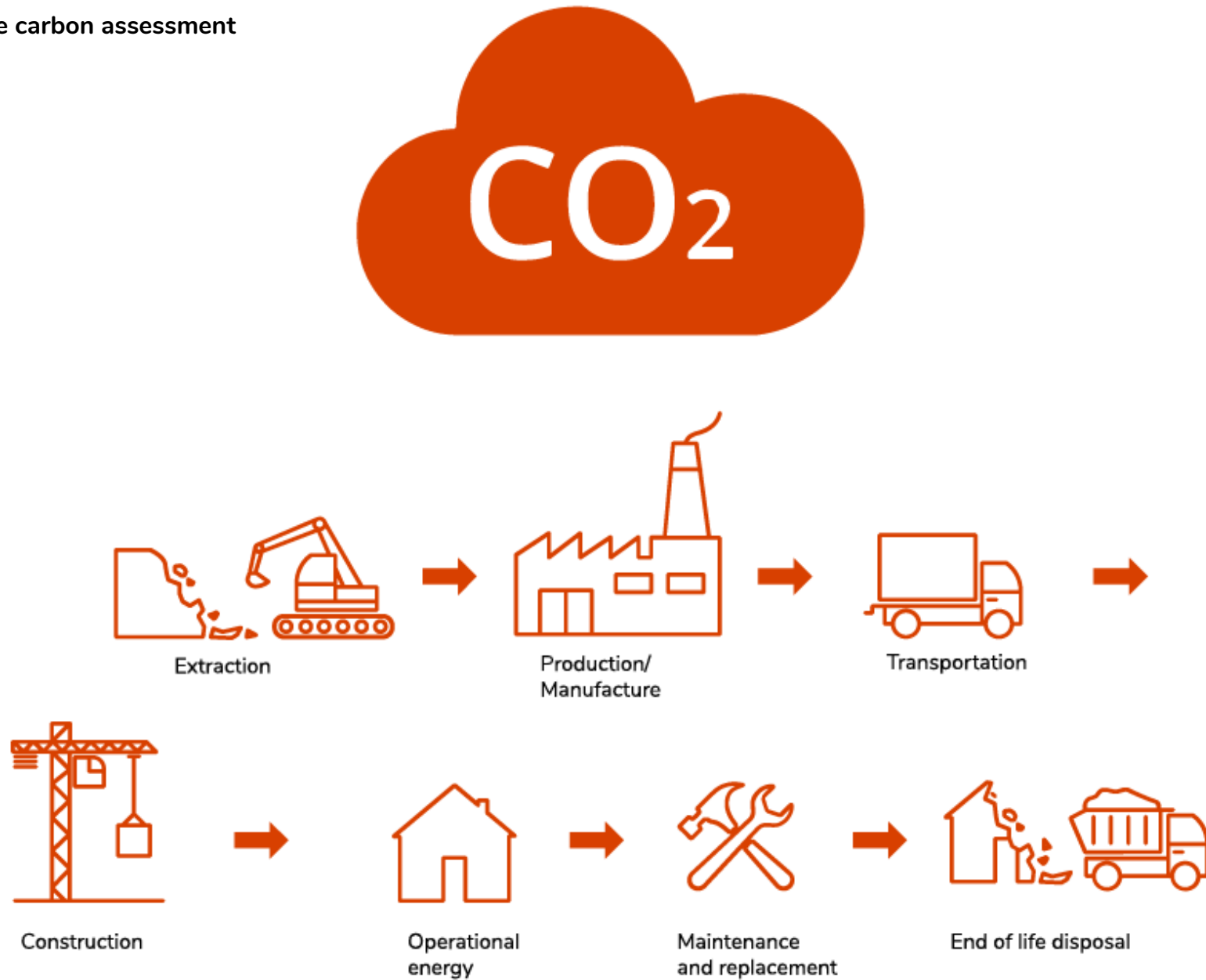


Figure 63: Identify carbon reductions in the key stages of a Whole life-cycle carbon assessment

Average percentages of embodied carbon (residential development)

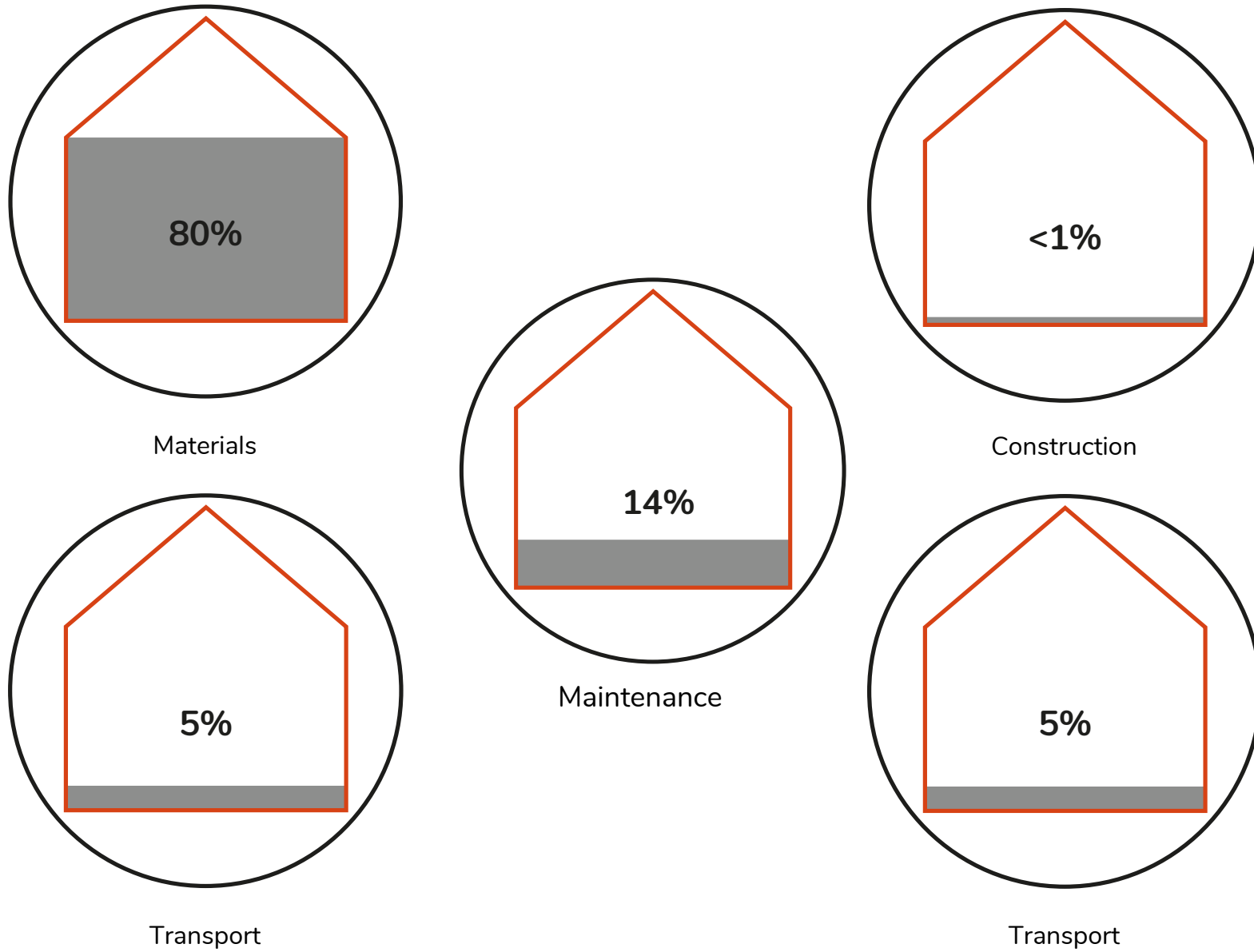


Figure 64: Focus on reducing embodied carbon for the largest uses

Design principles - Reducing embodied carbon

The scheme should:

- 6.15 use sustainably sourced and accredited low embodied carbon materials.
- 6.16 use locally sourced materials.

We support:

- 6.17 Reducing materials with high carbon footprints, (materials whose production process have high carbon emissions).
- 6.18 Whole Life-Cycle Carbon assessments submitted as supporting documentation as part of a planning application, focusing on the product and construction stages. (A building's product and construction stages are defined as modules A1-A5 of the RICS Professional Statement PS. RICS Guidance must be followed).
- 6.19 The off-setting of carbon emissions through a recognised scheme (this should be the last resort and off-setting should be local where possible).
- 6.20 Net zero carbon developments.

*Note: All design principles are applicable to all scales of development unless otherwise specified; *minor applications, **major applications*

Glossary

A

Access: The point(s) of vehicular or pedestrian entry/exit to a site.

Active Frontage: The interface between buildings and streets is characterised by multiple entrances and windows, which allows interaction between public realm and the premises facing the street.

Amenity Space: External space for recreational purposes.

B

Biodiversity metric: A biodiversity metric is a calculator which quantifies the existing biodiversity value of a site and compares it to the likely biodiversity value after an intervention (land management, building works, etc.). Biodiversity metrics are used to demonstrate whether developments can achieve a biodiversity net gain.

Biodiversity mitigation hierarchy: First, avoid adverse ecological impacts wherever possible. Then, mitigate impacts that are unavoidable. As a last resort, compensate for residual impacts which cannot be avoided or mitigated.

Block: A form of development where the perimeter is defined by streets.

Botanical surveys: When early investigations suggest that a valuable habitat or rare plant species may be present on a development site it's often necessary to complete a more detailed botanical assessment. This may take the form of specific surveys to detect a particular species or species group or it may be appropriate

to use the National Vegetation Classification (NVC) survey technique to obtain an accurate picture of plant communities.

Building Line: The line defined by the frontages of buildings along a street or road.

Building Interface: The area between the back of foot way on the street and the building line.

Built Form: Buildings and structures.

Bulk: The combined effect of volume and shape of a building or group of buildings. Also called massing.

C

Character: The combination of features of a building or a place that give it a distinctive identity.

Character Area: An area with distinct and recognisable pattern of elements that occur consistently to give the area a distinctive identity.

Character Study: A process of analysis to determine the elements and features that contribute to the unique character of a place.

Conservation Area: An area that has been designated as having special architectural or historical interest.

Consoles: Type of bracket or corbel, particularly one with a scroll-shaped profile: usually an ogee (S or inverted S curve) or double-ogee terminating in volutes (spirals) above and below. A console

projects about one-half its height or less to support a windowhead, cornice, shelf, or sculpture.

Context: The physical setting for a development.

Contextual analysis: The process of gathering information to understand a place.

Cul-de-sac/private drive layouts: Streets that are closed at one end, also known as no-through roads.

D

Datum line: A line to which dimensions are referred on engineering drawings, and from which measurements are calculated.

Density: A measure of the number of dwellings or people per hectare.

Design: The creative process of making spaces and places.

Design and Access Statement: A document that sets out the design approach proposed for a development. The document will also address any site constraints and opportunities

Design Code: A set of illustrated design rules and requirements, which instruct and advise on the physical development of a site or area. The graphic and written components of the code are detailed and precise, and building upon a design vision such as a masterplan or other design and development framework for a site or area.

Design Guidance: Documents that provide guidance on the appearance of development in a given area.

Design Principle: A statement that summarises design guidance.

Design Review: The Design Review process is a well-established way of improving the quality of design of developments and it is recognised in the National Planning Policy Framework. This is essentially a means for reviewing schemes with an independent, multi-disciplinary panel of built environment experts. Schemes can be reviewed at all stages of the planning application process but the ideal time for a review is at the concept/pre-application stage to benefit most from the review, adding value to the design. There are existing Design Review panels who could provide this service. Please contact the Council for more information.

Drawing trail: An itemised list of drawings required for a development proposal.

E

Elevation: An external face of a building, or the height of a site above sea level.

Enclosure: The arrangement of buildings, walls, trees etc to provide different levels of containment of a space.

F

Façade: The external face of a building or group of buildings that face the public realm.

Fenestration: The placement of windows on the exterior of a building.

Figure ground diagram: Two-dimensional map of a settlement that shows the relationship between built and unbuilt space. It is used in analysis of urban design and planning.

Focal point: A point of interest which makes a place unique and memorable in the public realm.

Footprint: The 2 dimensional shape created by a building or group of buildings on the ground.

Form: The physical appearance of a development – its 3-dimensional shape.

G

Grain: The general shape and direction of building footprints.

Green and blue infrastructure: All the natural features such as landscape and water.

Green infrastructure (GI): Green Infrastructure (GI) is a planned and managed network of multifunctional green spaces which can provide a healthy and rich environment. These can include: allotments, gardens, including communal green spaces within housing areas, green corridors, brownfield and greenfield sites, urban parks and gardens, registered commons, village and town greens, children's play space, natural and semi-natural habitat for wildlife, playing fields, cemeteries, pocket parks, country parks, woodland, nature reserves, Sites of Special Scientific Interest and Scheduled Monuments. It is a multifunctional landscape that

incorporates the widest range of functions an open space can support to unlock the greatest number of benefits.

H

Habitable rooms: Any room that is used for living and/or eating, cooking or sleeping. Enclosed spaces such as bath or toilet facilities, service rooms, corridors, laundries, hallways and utility rooms are excluded from this definition.

Heritage assets: A range of geographical components of the historic environment which have been positively identified as having a degree of significance meriting consideration in planning decisions. These include listed buildings; old buildings that are not listed but still have local historical importance; scheduled monuments; war memorials; historic wreck sites; parks; historic gardens; conservation areas, archaeological sites and so on.

Hierarchy: A logical sequence of spaces, streets or building forms, increasing or decreasing in size or density throughout a development.

I

Inclusive design: Designing with the needs of all users in mind, including the elderly, disabled, parents and carers.

L

Landmark: A building or structure that stands out from surrounding buildings.

Landscape appraisal: This is the consideration of the physical aspects of the site in order to identify key constraints and opportunities.

Landscape character: The distinct and recognisable pattern of elements and features in the landscape that makes one landscape different from another.

Landscape strategy: Includes the features to be retained on site, their intended function including public usage and the proposed height of vegetation including hedgerows.

Landscape structure: This incorporates existing landscape features and provides new ones to enhance and integrate the development and mitigate impacts.

Layout: The arrangement of buildings, streets and spaces in a development.

Legibility: The degree to which a place can be easily comprehended by its users so that navigation through that space is easily achieved.

Local distinctiveness: Similar to character – the features that define an area or development.

M

Massing: The volume of a building or group of buildings.

Masterplan: An evolving plan that establishes the framework and key elements of a site including routes, spaces, uses and so on

Mixed-use: The combination of complementary uses within a building, site or area.

Movement: The passage of people and vehicles through buildings, places and spaces.

Movement network: The term “movement networks” refers to the physical infrastructures that allow people to navigate between land uses or destinations.

N

Nodes: A place where activity and routes are concentrated.

O

Open space: Open spaces include public, shared and private outdoor spaces with a range of sizes and locations.

P

Passive surveillance: The monitoring of public space through the placement of buildings and activities in such a way as to maximise visibility and foster positive social interaction.

Perimeter Blocks: Development blocks where buildings front onto streets and spaces and back onto rear gardens.

Permeable: Easy to move through.

Permeability: The degree to which a residential development can be penetrated by foot, cycle and vehicle and the connectivity of the development to adjacent developments.

Pilasters: A rectangular column, especially one projecting from a wall.

Place: A space in the built environment that has some meaning for people due to the activities and uses which characterise the space, or the quality of the space itself.

Place-identity: Refers to a cluster of ideas about a place and identity in the fields of geography, urban planning, urban design and landscape architecture. Place-identity is sometimes called urban character, neighbourhood character or local character. It refers to the meaning and significance of places for their inhabitants and users.

Placemaking: Creating the physical conditions that residents find attractive, safe, neighbourly and legible.

Public Art: Public Art is complementary to good urban and building design, as part of social investment in new housing, the design and use of community and public spaces. Public art can be anything physical, that is made by a professional artist or crafts person, is bespoke and of high quality. Public art can be a stand-alone work of art (a sculpture or statue) or other artistic representation including or integrated within street furniture, paving, hard and soft landscaping or architectural detailing.

Public realm: Any publicly owned streets, pathways, rights of way, parks, publicly accessible open spaces and any public and civic buildings and facilities.

Public and private space: Private space might be described as space that is owned and maintained by a single individual, family or institution. Public space is space which is not only in the public domain but in public ownership. Space, that is, which is assigned to and maintained by the community, whether in the form of the parish, the town, or the city.

R

Root Protection Area: A minimum area around a tree deemed to contain sufficient roots and rooting volume to maintain the tree's

viability and where the protection of the roots and soil structure is treated as a priority.

Rooting/soil volume: The amount of soil available to a newly planted tree. e.g. for a tree to reach its growth potential it will need to have access to sufficient volumes of soil. For a larger tree species such as an Oak you will need to provide at least 25m³ of soil in a form usable for the tree.

S

Scale: The size of a building relative to neighbouring buildings.

Science Vale UK: Science Vale UK (not to be confused with Vale of the White Horse) is a significant area of economic growth and is a global hotspot for enterprise and innovation. Spread across the South Oxfordshire and Vale of White Horse districts, it is home to a significant proportion of the region's scientific, research and development, and high technology businesses.

Sense of place: A property of space with strong identity and character that is deeply felt by local inhabitants and visitors.

Space: Abstract term referring to a location that has not had a specific human value or purpose attached to it. This is as opposed to a 'place' which has an identifiable character, or a 'location' which has geometrical certainty. An area of land which is not occupied by buildings.

Street furniture: This includes street signs, posts, lighting columns, seating and items that are placed within streets and spaces.

Street hierarchy: The order or ranking of a street within a development. A standard hierarchy normally contains the following: primary street, secondary street, tertiary street.

Streetscape: The character and appearance of the street environment.

Sun path/angle diagram: Sun path diagrams are able to show you how the sun will impact your site and building throughout the year.

Sustainable Drainage Systems (SuDS): A more natural way of draining surface water from a site than routing the water through a pipe to a watercourse.

T

Townscape: The overall effects of the combination of buildings, spaces views and features (the urban equivalent of landscape).

Termination, terminated view: A building or other feature which is placed at the end of a view down a street or square, to aid enclosure or provide a landmark.

Topography: A description of the shape of the land.

Tree Pit: A site specific planting pit design that will provide suitable growing conditions for a tree to be planted and become established, and in time grow to maturity. It should provide sufficient volume of soil in an oxygenated, hydrated and uncompacted form to promote healthy root establishment. The design of a tree pit will very much depend on the planting environment e.g in soft open ground, or within a hard surfaced area.

U

Urban Design: The process of making places, incorporating the design of buildings, spaces and details.

Urban Grain: The pattern development in a settlement.

Use Class Order: Most land and buildings in England are categorised depending on their purpose or use and these categories are set out by the use class order.

V

Vegetation: Vegetation may be defined as the patchwork of plant species arrayed across the landscape. Vegetation can refer to a wide range of spatial scales and plant communities. It includes a variety of forms such as trees, shrubs, grasses, herbaceous, and non-vascular plants like mosses. It can also include cultivated gardens and lawns or roadside weed patches.

Other

20-minute neighbourhoods: A complete, compact and connected neighbourhood, where people can meet their everyday needs within a short walk or cycle. The idea of the 20-minute neighbourhood presents multiple benefits including boosting local economies, improving people's health and wellbeing, increasing social connections in communities, and tackling climate change. As defined by the Local Transport and Connectivity Plan, a 20 minute neighbourhoods is a new expression for a design concept that plans for essential facilities within 20 minutes' walk from home. A 20 minute walk will get most people around 1.5 km or a mile. The concept is that all essential everyday facilities should be within that distance so it is easy for people to base their lives on walking rather than using a car. Facilities should include shops, recreational

opportunities, parks, community facilities, access to public transport (mostly bus stops) and such like. The concept fits in with the goals of low traffic neighbourhoods (LTNs) which minimise traffic within the neighbourhood.

